



# FUSION SERIES

USER MANUAL FOR FUSION CLASSIC 100 & 200

General Description	6
Safety Information	6
Warranty and Repair Information	8
Product Overview	10
Principle of Operation	10
Controlled Elements	11
Controls	12
Fusion 200 Specific Components	13
Specifications	14
Pump Setup Powering On/Off	16
Loading a Syringe	17
Adjusting the Safety Nut	20
Pump Operation	21
Navigating Between Screens	22
Entering Numbers	22
Entering Letters	22
Mode Selection Screen	23
Basic Mode	24
Syringe Selection	24
Infusion/Withdrawal (Fusion 200 only)	26
Flow Rate	27
Start-Time Delay	27
Options	28
Flow-Rate Units	28
Saving Run Parameters	28
Priming/Bolus Rate	28

Enable Volume Lock	28
Multi-Step Mode	29
Setup	29
Syringe Selection	29
Total Steps	29
Loop All	29
Sub-Loops	29
Flow-Rate Units	31
Step Parameters	31
Volume	32
\nInfusion/Withdrawal (Fusion 200 only)	32
Flow Rate	33
Static Flow Rate	34
Variable Flow Rate	34
Start-Time Delay	34
Step Loop	34
Pump Control	35
Run Status	36
System Settings	37
Touchscreen Toggle	37
Baud Rate	38
Power Settings	39
Motor Power`	39
LCD Power-Off Time	39
Pump Control by Computer	40
Cable Requirements	40

Connecting	40
COM Port Settings	41
Pump Commands	42
Chemyx Pump Controller Programs	47
Pump Maintenance	48
Lubricating the Pump	48
Replacing the Fuse	48
Pump Accessories	49
Footswitch	49
Connecting the Footswitch	49
Using the Footswitch	49
10-Channel Syringe Rack (Fusion 200 only)	49
Attaching the Rack	50
Appendices	51
Appendix A: Syringe Volume/Diameter Reference Table	51
Appendix B: Available Parts	55
Appendix C: Contact Information	56

## INTELLECTUAL PROPERTY

All Intellectual Properties, as defined below, owned by or which is otherwise the property of Chemyx Inc. or its suppliers relating to the Chemyx syringe pumps, including but not limited to, accessories, parts or software relating thereto (Chemyx Syringe Pumps), are proprietary to federal and state laws, and international treaty provisions. Intellectual Property includes but is not limited to, inventions (patentable or unpatentable), patents, trade secrets, copyrights, software, firmware, computer programs, and related documentation and other works of authorship. Moreover, you agree that you will not, and will not attempt to, modify, prepare derivative works of, reverse engineer, disassemble the Chemyx syringe pumps, decompile or otherwise attempt to create source code from the related software/firmware. No title to or ownership in Intellectual Property is transferred to you. All applicable rights of the Intellectual Property shall remain with Chemyx and its suppliers.

# General Description

## Safety Information

Please read the following safety precautions to ensure personal safety and operational longevity of the Chemyx syringe pump. Chemyx is not responsible for the equipment if used in a manner not specified by the manufacturer; warranty coverage provided by the equipment may be dropped as a result.

**CHEMYX PRODUCTS ARE NOT APPROVED FOR CLINICAL USE ON HUMANS.**

### Use Proper Power Supply

Chemyx is not responsible for the use of power supplies outside the stated electrical specifications or failure to switch the power converter from 220V to 110 V while in the 220V environment or vice versa.

### Ground Product

The product should be properly grounded.

### Do Not Open The Pump

Warranty coverage will be lost if the pump is opened without authorization from Chemyx. Do not touch any electrical connectors on or in the product.

### Do Not Operate With Suspected Failures

Even though the pump can operate at extremely fast speeds, the user must determine the proper flow rate for any given application. For instances, pumping at 90 mL/min using a 20-gauge needle will cause stalls and/or potential bursting of the syringe. Chemyx is not responsible for any damage that might result from situations similar to the example above.

## **Pinch Hazard**

Do not place fingers between the pusher block and the end block while the pump is running.

## **Observe all Warning labels on Product**

Read all labels on the product to ensure proper usage.

## **Chemyx is not Responsible for Syringe Damage**

The user is responsible for wetting ground glass syringes and setting and tightening the safety collar/bar appropriately.

# Warranty and Repair Information

## Warranty Information

Chemyx provides a two-year limited warranty (1) first year for parts and labor (2) second-year for parts only from the shipment date for its pumps against defects in materials and workmanship. Chemyx will repair product that proves defective during its stated warranty period. To get warranty repair the customer is responsible to send the pump to Chemyx.

The foregoing warranty will not apply to damage resulting from:

- ▶ Improper or inadequate maintenance or operation.

---

- ▶ Unauthorized modification or misuse of the product.

---

- ▶ Operation outside the electrical specifications for the product.

---

- ▶ Operation outside the temperature specifications for the product.

---

- ▶ User-induced internal and external contaminations of the instrument.

---

- ▶ Failure to use proper surge protection.

---

- ▶ Improper product return, packaging, and shipping

---

- ▶ Removing serial number from syringe pump

## Repair Information

Chemyx can repair the syringe pump without major damage. You must contact Chemyx Inc by either email or phone before returning the product. Chemyx will issue a Return Authorization (RA) number to you.

You must contact Chemyx (call +1 281-277-5499 or visit [www.chemyx.com/contact-us](http://www.chemyx.com/contact-us)) before returning a product. Chemyx will issue a Return Authorization (RA) number to you.

Return products to:

Chemyx Inc.

10905 Cash Road | Stafford, TX 77477 USA.



## Repair Facilities and Parts

Chemyx can repair any syringe pump without major damage. You must contact Chemyx call +1 281-277-5499 or email us at info@chemyx.com before shipping a product for repair. Chemyx will issue a Return Authorization (RA) number to you.

Return products to:

### **Chemyx Returns**

10905 Cash Road | Stafford, TX 77477 USA

## Dead Pixel Policy

During the LCD Monitor manufacturing process, it is not uncommon for one or more pixels to become fixed in an unchanging state. The visible result is a fixed pixel that appears as an extremely tiny, dark or bright dot. In almost every case, these fixed pixels are hard to see and do not detract from display quality or usability. A display with three to seven bright or dark dots is considered normal and within industry standards. If your screen displays more than seven dead pixels during the warranty period, your system will qualify for warranty replacement. Please see the Limited Warranty section for details on how to activate a warranty claim.

## Serial Numbers

The serial number is located on the back, top left corner or center of the pump under a small barcode. Removal of the serial number label will void the warranty.

## Calibrations

Chemyx pumps are pre-calibrated upon arrival to your site. All calibrated parameters are within stated accuracy and precision specifications of the pump. Although the pump is highly accurate, syringes of different materials can attribute significant volume errors. Typically, these errors can range from 1% for glass syringes to 5% for plastic syringes. Chemyx is not responsible for errors generated from syringes.

# Product Overview



Fusion 100



Fusion 200

Chemyx Fusion Series syringe pumps are designed to handle every type of high-precision dosing application. The units' flexibility with syringe types and sizes and an advanced software interface make this line of high-precision syringe pumps integrable into any operation or laboratory work flow. Thoroughly durable both inside and out, the Chemyx Fusion syringe pumps are designed to provide years of constant and reliable service.

## Principle of Operation

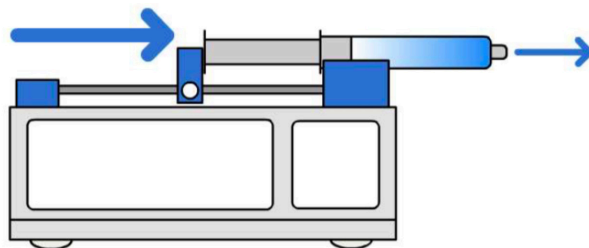

A syringe pump is a small, positive-displacement pump used to gradually transfer precise volumes of fluid. All Chemyx Fusion-series syringe pumps are driven via a stepper motor. This stepper motor precisely turns a lead screw that is threaded through a pusher block, which causes the pusher block to move. When the pump is in infusion mode, the pusher block pushes against the plunger of a secured syringe, causing the fluid to be ejected at an accurate and precise rate.

If the pump is capable of withdrawal, the plunger of the syringe is held by brackets on the pusher block. When the stepper motor turns in the opposite direction, the pusher block moves such that the syringe plunger is pulled, thus drawing fluid into the syringe.

For the Fusion Series syringe pumps, the pusher block moves to the right for infusion and to the left for withdrawal.

## Controlled Elements

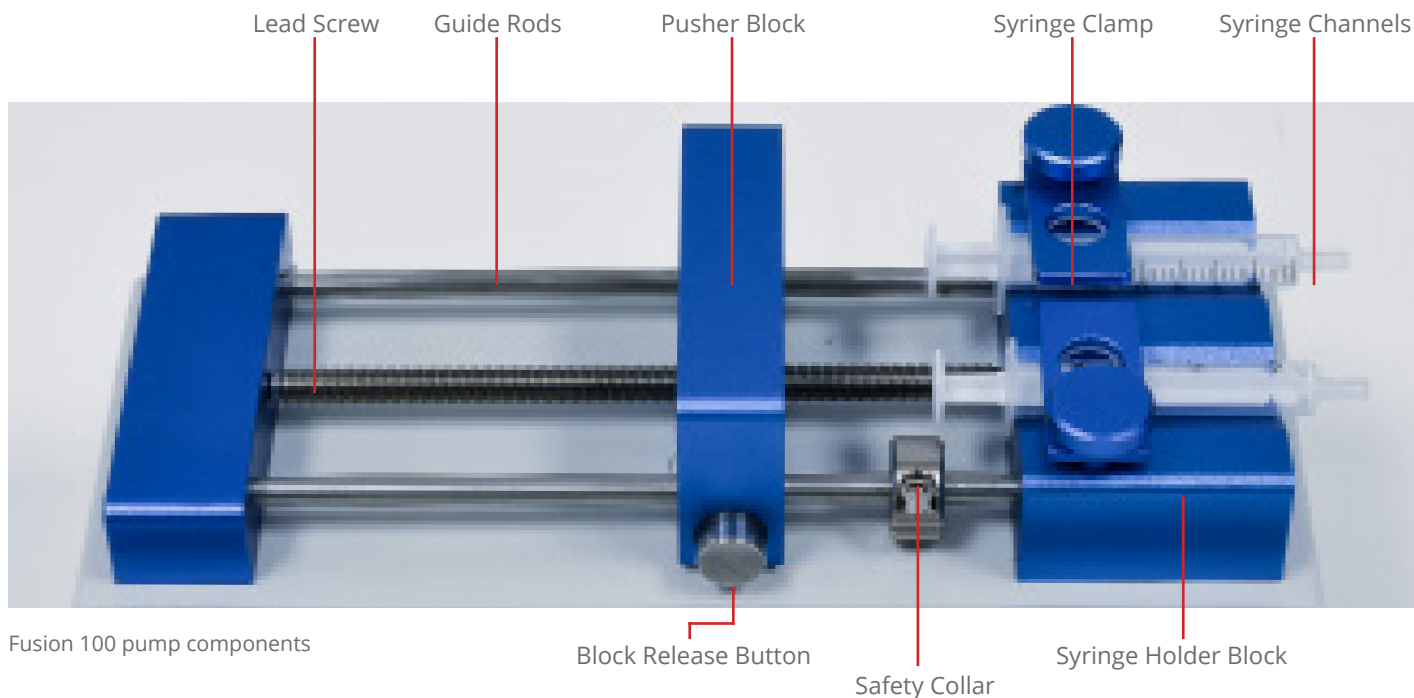

All Fusion Series pumps have a single lead screw through which the pusher block is threaded. The pusher block moves when the lead screw turns. The two guide rods keep the pusher block horizontal and perfectly perpendicular to the lead screw. The block-release button disengages the pusher block from the lead screw, which allows the pusher block to be easily moved to a new position as long as the button is held. Releasing the button will lock the pusher block back in place.

Syringes are placed on the syringe-holder block in the v-shaped grooves, or channels, and held securely using syringe clamps. The Fusion 100 and 200 both have two syringe channels, while the Fusion 400 has four smaller syringe channels.

The safety collar of the Fusion 100 and 200 helps protect the integrity of syringes by keeping the pusher block from pushing on a completely depressed syringe.

## Controls

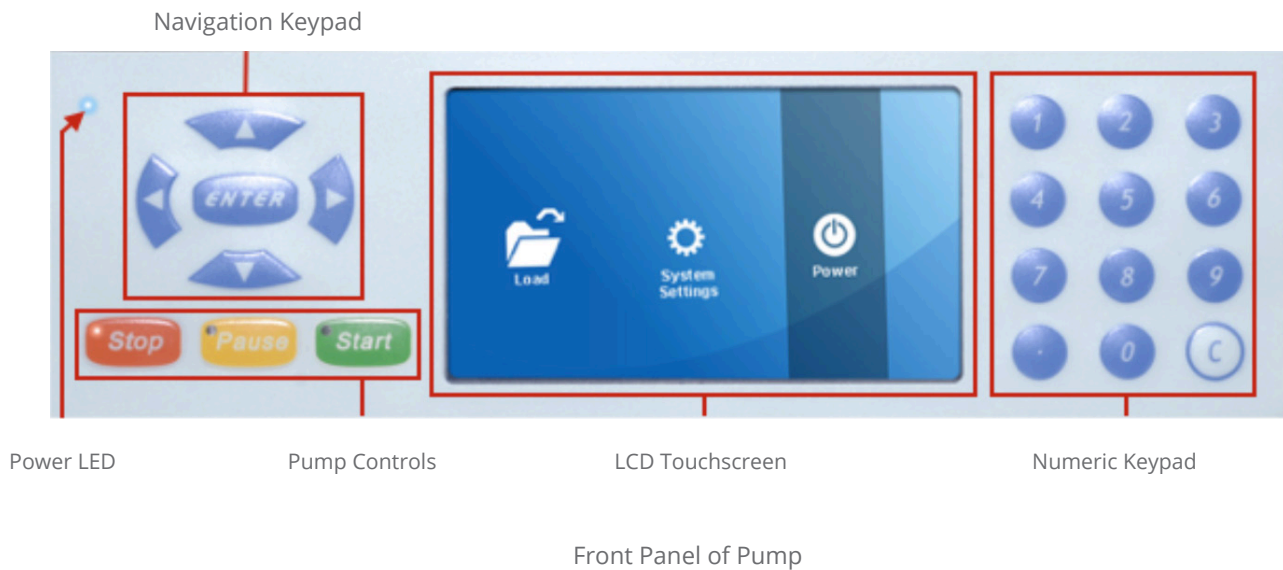

The Fusion Series uses a bright, 4.25", resistive, LCD touchscreen with an intuitive graphical user interface (GUI) for setting up detailed pump run methods. Buttons and entry fields within the GUI are all selectable using the touchscreen. As a resistive, LCD touchscreen, the interface can be operated with any object, not just the touch of a fingertip. Selecting elements by touch only requires a small amount of pressure; however, please do not use sharp objects as they may damage the screen.

The Fusion series also includes physical navigation controls, allowing users to manually maneuver between selectable GUI elements without touching the screen. Inputting numbers and letters within the GUI is done using the physical numeric keypad. The physical pump control keys are used to start, pause, and stop pump activity.

The power LED and pump-control LEDs allow users to easily discern whether the pump is on and whether it is currently running, paused, or stopped.

## Fusion 200 Specific Components

Bracket Release Knob

Flange Retaining Bracket

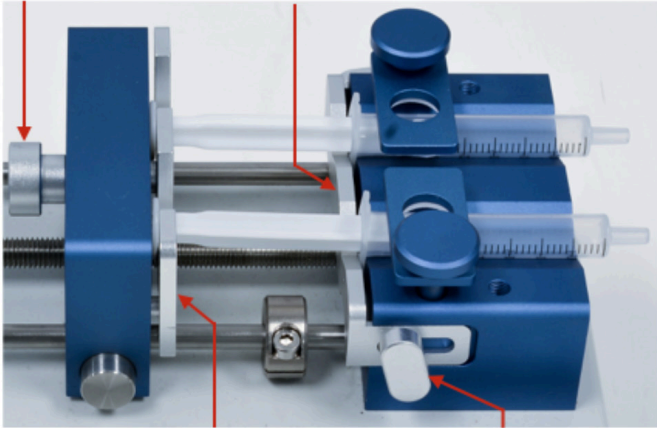

Plunger Retaining Bracket

Bracket Release Knob

In addition to having all of the same features and components of the Fusion 100, the Fusion 200 is capable of both infusion and withdrawal. Because of this difference, the Fusion 200 uses adjustable retaining brackets on the pusher block and the syringe-holder block that keep the syringe in place during both infusion and withdrawal.

## Fusion 400 Specific Components

Bracket Release Knob

Flange Retaining Bracket

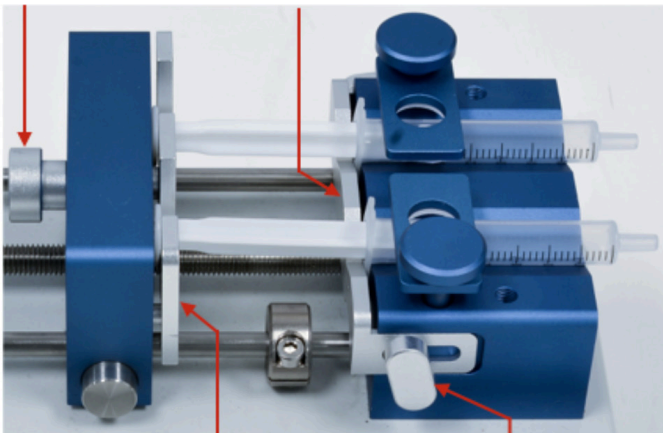

Plunger Retaining Bracket

Bracket Release Knob

In addition to having all of the same features and components of the Fusion 100, the Fusion 200 is capable of both infusion and withdrawal. Because of this difference, the Fusion 200 uses adjustable retaining brackets on the pusher block and the syringe-holder block that keep the syringe in place during both infusion and withdrawal.

# Fusion 100 Data Sheet



The Fusion 100 high-precision infusion pump has a broad range of applications and supports both simple runs and variable, multi-step volume and rate profiles.

## TECHNICAL SPECIFICATIONS

<b>MODE</b>	Infuse Only
<b>MINIMUM FLOW RATE</b>	0.0001 $\mu$ L/min (with 0.5 $\mu$ L syringe)
<b>MAXIMUM FLOW RATE</b>	128 mL/min (with 60mL syringe)
<b>LINEAR FORCE</b>	35lb (15.9kg)
<b>SYRINGE SIZE (MIN/MAX)</b>	0.5 $\mu$ L to 60 mL syringe
<b>STEP RESOLUTION</b>	0.098 $\mu$ m/step
<b>OPERATIONAL TEMPERATURE</b>	4°C to 40°C (40°F to 104°F)
<b>STORAGE TEMPERATURE</b>	-10°C to 70°C (14°F to 158°F)
<b>ACCURACY</b>	$\pm$ <0.35%
<b>REPRODUCIBILITY</b>	$\pm$ <0.05%
<b>CONNECTIVITY</b>	USB-B, RS232 and TTL Ports
<b>POWER</b>	110/220 VAC
<b>MULTI STEPS</b>	program steps up to 99 step / loop steps up to 99 loop
<b>PARAMETER SETTING</b>	option to choose time or rate
<b>SCREEN SIZE / TYPE</b>	4.3 inch LCD Touch Screen
<b>DIMENSIONS</b>	9.5 x 6.8 x 4.4 inches (24 x 17 x 11 cm)
<b>MOTOR DRIVE</b>	1.8° Stepper Motor with Micro-stepping
<b>WEIGHT</b>	7lbs (3kg)

# Fusion 200 Data Sheet



The Chemyx Fusion 200 high precision infuse and withdraw syringe pumps has a broad range of applications. This system supports both simple runs and variable, multi-step and rate profiles, along with a multi-syringe rack accessory.

## TECHNICAL SPECIFICATIONS

<b>MODE</b>	Infuse & Withdraw
<b>MINIMUM FLOW RATE</b>	0.0001 $\mu\text{L}/\text{min}$ (with 0.5 $\mu\text{L}$ syringe)
<b>MAXIMUM FLOW RATE</b>	85 mL/min (with 50mL syringe)
<b>LINEAR FORCE</b>	50lb (23kg)
<b>SYRINGE SIZE (MIN/MAX)</b>	0.5 $\mu\text{L}$ to 60 ml syringe
<b>STEP RESOLUTION</b>	0.046 $\mu\text{m}/\text{step}$
<b>OPERATIONAL TEMPERATURE</b>	4°C to 40°C (40°F to 104°F)
<b>STORAGE TEMPERATURE</b>	-10°C to 70°C (14°F to 158°F)
<b>ACCURACY</b>	$\pm < 0.35\%$
<b>REPRODUCIBILITY</b>	$\pm < 0.5\%$
<b>CONNECTIVITY</b>	USB-B, RS232 and TTL Ports
<b>POWER</b>	110/220VAC
<b>MULTI STEPS</b>	program steps up to 99 step / loop steps up to 99 loop
<b>PARAMETER SETTING</b>	option to choose time or rate
<b>MODULAR CAPABILITY</b>	10-Channel Syringe Rack
<b>MOTOR DRIVE</b>	1.8° Stepper Motor with Micro-stepping
<b>DIMENSIONS</b>	9.5 x 6.8 x 4.7 inches (24 x 17 x 12 cm)
<b>WEIGHT</b>	7lbs (3kg)

# Pump Setup

## Powering On/Off the Pump

To provide power to the pump, an IEC 60320 C13 cable should be plugged into the power socket on the back of the pump. The cable should be plugged into an appropriate power source (110V or 220V) with proper grounding. Adjust the voltage-converter switch on the back of the pump such that the value displayed on the switch corresponds with the voltage of the power supply.

The power switch for the pump is located on the back, above the power socket. Upon flipping the switch to the “on” position, the blue LED power light on the front of the pump will immediately turn on, along with the red LED light on the Stop key. In a few seconds, a beep will sound, and the LCD screen will display an initial startup screen.

The startup screen displays the version of the firmware currently installed on the pump at the top of the screen. The startup screen will display for approximately five seconds as indicated by the countdown on the right of the startup screen.

After the startup screen, the LCD screen will display the last mode the pump was in.





# Loading a Syringe

The Fusion series can accommodate up to two syringes in the Fusion 100 and 200 models, while the Fusion 400 can house up to four syringes. The Fusion 200 can be expanded to 10 channels using the Chemyx 10-Channel Syringe Rack accessory. The volume of the syringes can vary from a minimum of 0.5  $\mu\text{L}$  up to a maximum of 60 mL (10 mL maximum for the Fusion 400). Syringes of any material (e.g., glass, plastic, stainless steel, etc.) can be used; however, some use cases may require syringes that are more accurate and durable.

## Fusion 100

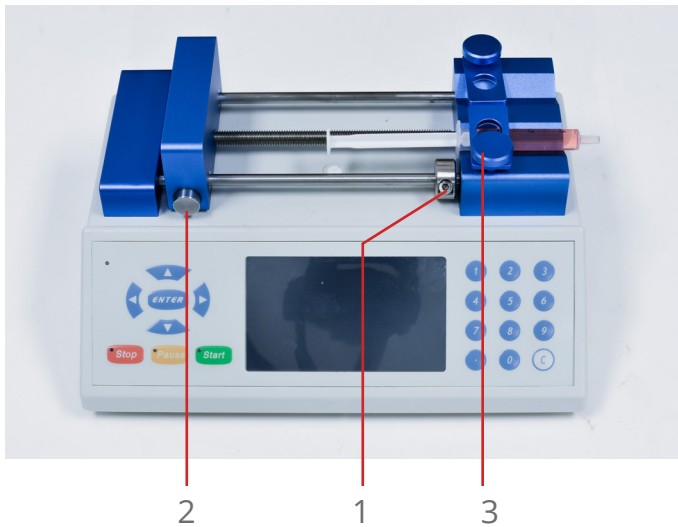

1. If necessary, move and tighten the infusion safety collar (see Adjusting the Safety Collar).
2. While pressing in the lock-release button, slide the pusher block all the way to the left.
3. Pull up on the spring-loaded syringe clamp and place the syringe in one of the channels of the syringe-holder block. Ensure that the flange of the syringe barrel is flush against the edge of the syringe-holder block. Slowly lower the syringe clamp to secure the syringe in place.

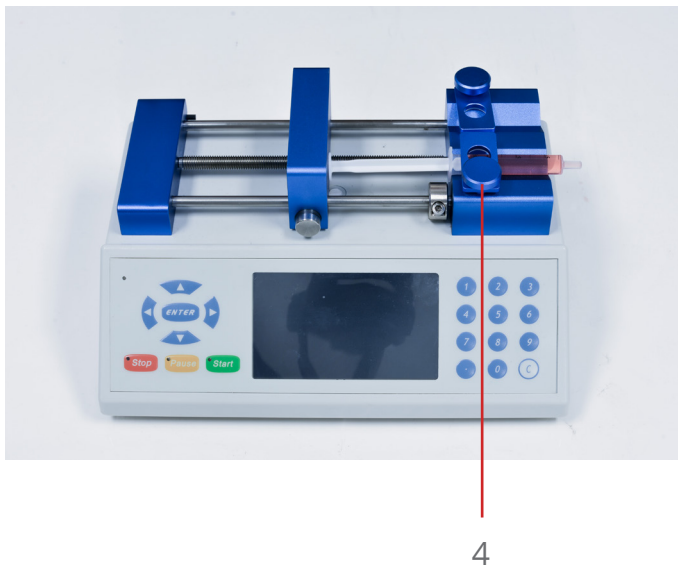

4. Press the lock-release button and slide the pusher block to the right until it is flush against the syringe plunger.

## Fusion 200

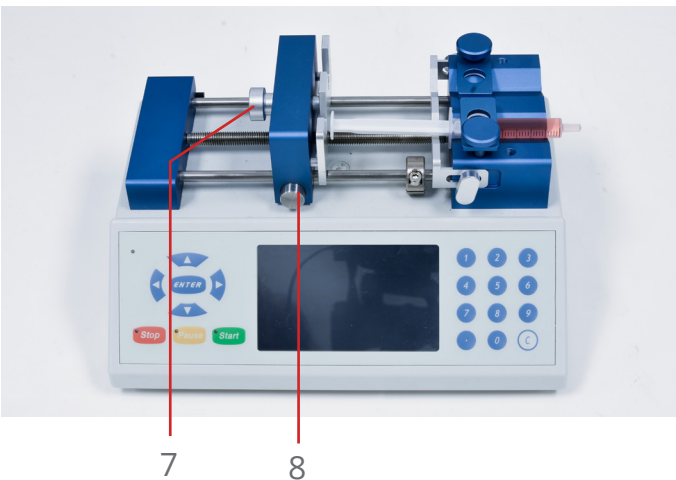
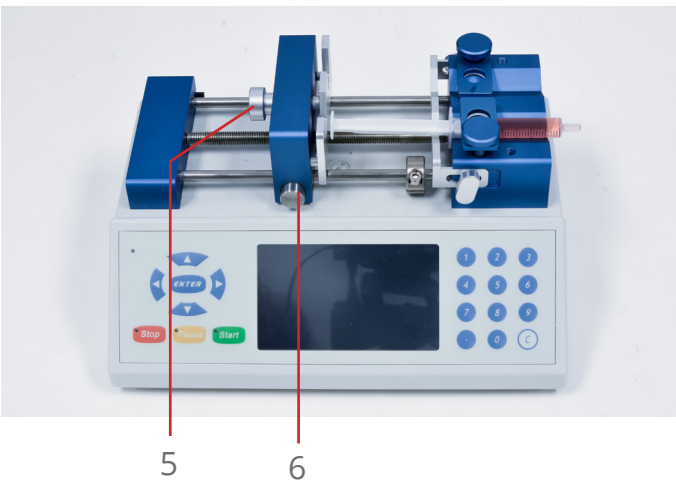
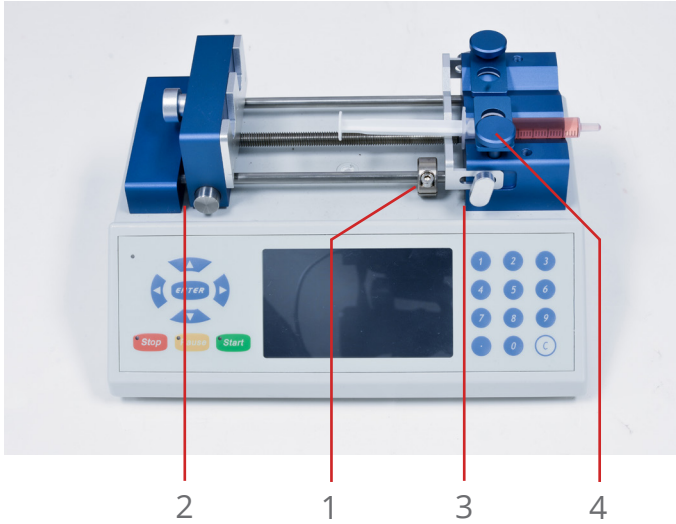

1. If necessary, move and tighten the infusion safety collar (see Adjusting the Safety Collar).
2. While pressing in the block release button, slide the pusher block all the way to the left.
3. Loosen the screw knobs for the flange retaining bracket and adjust the bracket such that the flange of the syringe barrel will fit in between. Do not tighten the bracket, yet.
4. Pull up on the spring-loaded syringe clamp and place the syringe in one of the channels of the holder block. Ensure that the flange of the syringe barrel is flush against the edge of the holder block. Slowly lower the syringe clamp to secure the syringe in place.
5. Loosen the bracket clamp knob for the plunger retaining bracket and adjust the gap such that the plunger cap of the syringe may fit.
6. Press the block release button and slide the pusher block to the right until it is flush against the syringe plunger. The plunger cap for the syringe should fit in the gap between the bracket and the pusher block.
7. Tighten the bracket clamp knob for the plunger retaining bracket to secure the syringe plunger in place.
8. Move the flange retaining bracket flush against the flange of the syringe barrel and tighten the bracket clamp knobs to secure the syringe barrel flange in place.

## Fusion 200

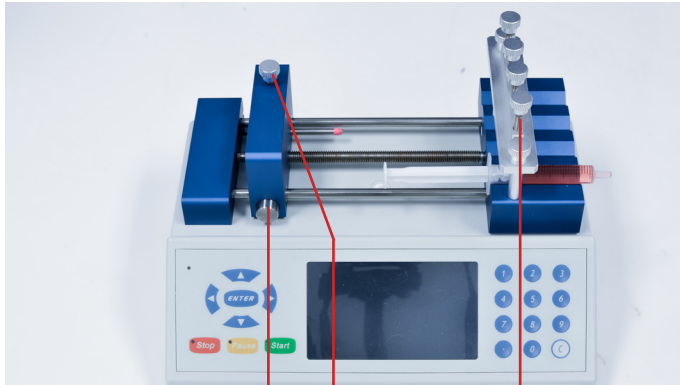

2 1

3

1. If necessary, move and tighten the infusion safety collar (see Adjusting the Safety Collar).
2. While pressing in the lock-release button, slide the pusher block all the way to the left.
3. Pull up on the spring-loaded syringe clamp and place the syringe in one of the channels of the syringe-holder block. Ensure that the flange of the syringe barrel is flush against the edge of the syringe-holder block. Slowly lower the syringe clamp to secure the syringe in place.
4. Press the lock-release button and slide the pusher block to the right until it is flush against the syringe plunger.

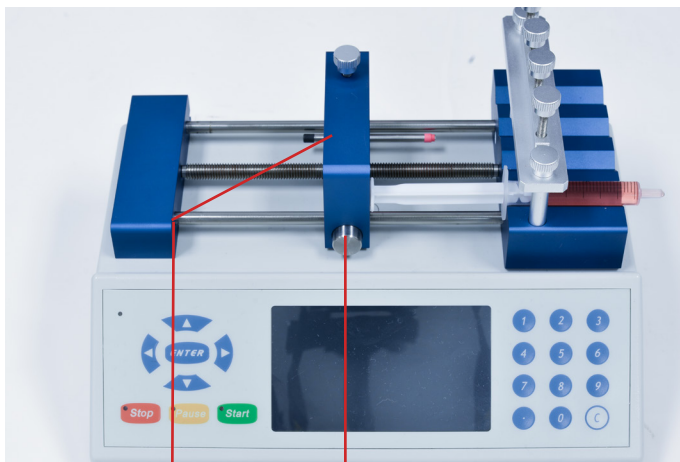

5

6

5. Loosen the bracket clamp knob for the plunger retaining bracket and adjust the gap such that the plunger cap of the syringe may fit.
6. Press the lock-release button and slide the pusher block to the right until it is flush against the syringe plunger. The plunger cap for the syringe should fit in the gap between the bracket and the pusher block.

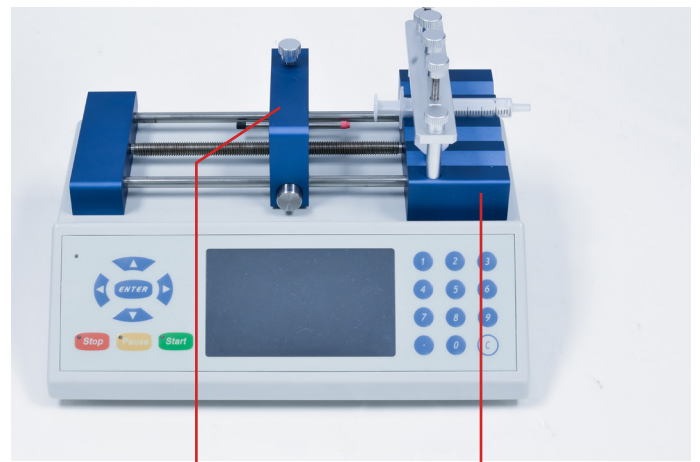

7

8

7. Tighten the bracket clamp knob for the plunger retaining bracket to secure the syringe plunger in place.
8. Move the flange retaining bracket flush against the flange of the syringe barrel and tighten the bracket clamp knobs to secure the syringe barrel flange in place.

## Adjusting the Safety Nut

The Fusion series of pumps can generate a significant amount of linear force. While this is extremely useful for dispensing viscous fluids at higher flow rates, the higher linear force of the Fusion series can also potentially damage the syringes in use. One source of potential damage of a syringe may occur when the plunger of the syringe is completely depressed, and the pusher block is still pushing against the syringe. Depending on the material of the syringe (i.e., glass or plastic) and the thickness of the plunger, the pressure from the pusher block could bend, distort, or just break the syringe.

To protect against this potential problem, Fusion syringe pumps use safety collars (Fusion 100 and 200) and safety bars (Fusion 400) to physically stop the pusher block before it can completely depress the syringe plunger. When a pusher block hits the safety mechanism and can no longer move forward, the pump will stop running, emit a long beep, and enter pump-stalled mode.

### Fusion 100 and 200

Adjusting the safety collar requires the use of the hex key, conveniently stored on the back left of the pump, right above the power switch. Loosening the hex screw on the safety collar allows for the collar to be slid freely along the guide rod and then securely tightened to set the position of the safety collar. The position of the safety collar should be set slightly further from the syringe-block holder than the top of syringe plunger when fully depressed.

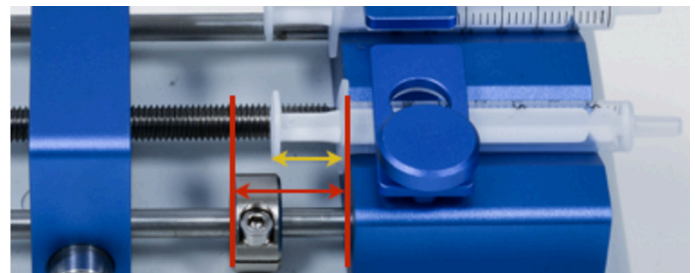

Safety collar adjustment

#### Caution:

On the Fusion 200, during withdrawal, a syringe plunger can potentially be pulled out from the syringe, which could cause the contents of the syringe to leak out. Users should be especially aware of the length of the plunger and the point where the withdrawing pusher block will exceed that length. There are no safety collars on the Fusion 200 to prevent too much withdrawal.

### Fusion 400

The Fusion 400 uses a safety bar instead of a collar to limit the distance the pusher block may travel. By loosening the safety bar clamp knob on top of the pusher block, the safety bar can be slid left or right. The safety bar should be set such that the length of the bar exposed on the right side of the pusher block is longer than the distance from the top of a fully depressed syringe plunger to the edge of the syringe-holder block. Once the safety bar has been set to the proper length, tightening the safety bar clamp knob will keep the bar from moving.

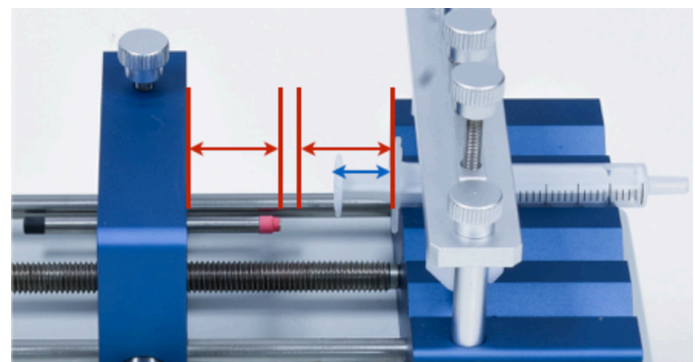

Safety bar adjustment

# Pump Operation

## Operating Interface

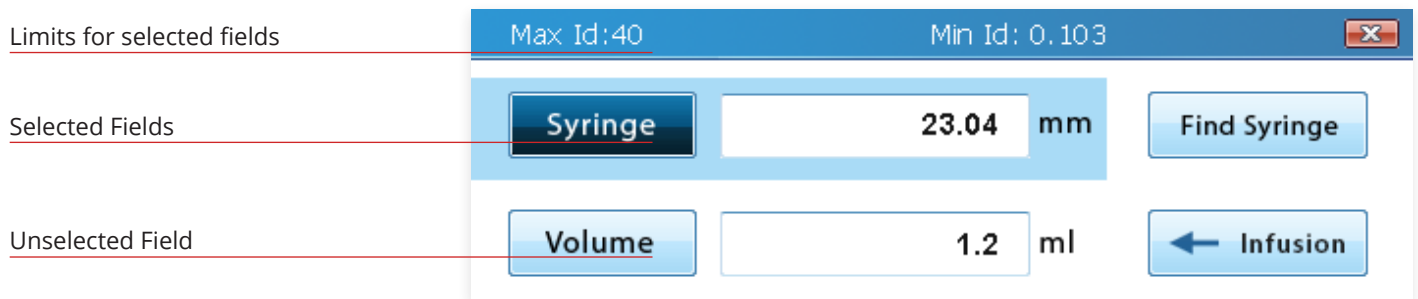

The LCD screen displays a graphical user interface (GUI) from which all the pump settings and run parameters are entered. Whenever an item is currently selected, the color scheme of the element typically turns to a darker shade of the color. For example, the light blue buttons turn dark blue when selected, and the white background surrounding an unselected editable text field turns blue when the field is selected and available for editing. Also, when a GUI element is selected, the top blue bar will show the activity performed (buttons only) or show the limits to the values that may be entered for the selected field (editable fields only).

Selecting the items that will be modified can be done two ways: (1) using the LCD touch screen or (2) using the navigation keypad.

All of the elements of the GUI can be interacted with by touch. Typical touch interactions are tapping a finger on a button or text field or sliding a finger to scroll. As a resistive touch screen, these interactions are not restricted to only ungloved fingertips. Many types of objects can be used to select items on the screen with only very slight pressure, but avoid using sharp objects, as they may permanently damage the screen.

Elements of the GUI may also be selected using the navigation keypad on the front of the instrument to move between the elements.

### Tip:

Users may find the navigation keypad easier to use for scrolling through items in a scrollable list, such as the list of syringes in the syringe library.

To activate (or “press”) a button using the navigation keypad, select the button element such that it is highlighted and then press the **ENTER** key at the center of navigation keypad. Editable fields can immediately be edited upon selection without the need to press the **ENTER** key.

## Navigating Between Screens

All of the screens in the Fusion Series GUI exist in a hierarchy, with the Mode Selection screen at the top. Entering a new screen is performed simply by activating, or tapping, a button or icon that opens the new screen.

To return to the previous screen, tap or activate the red "X" button in the top right of the screen. This will "close" the current screen, and return to the screen that was used to enter the closed screen. This can also be accomplished by pressing the Stop key on the front of the instrument when the pump is not running.



## Entering Numbers

Most editable fields will require the user to enter numbers, which is done using the numeric keypad on the front of the instrument.

Upon first selecting an editable field, pressing any number will first clear the old value and replace it with the new value. This only applies when first selecting the field. On a field that has already been selected and edited, any further edits will just append the number to the end. In such a case, to clear the current value in the field, press the white **C** key on the numeric keypad.

Values entered in an editable field are accepted upon pressing the **ENTER** key, selecting a new element, or pressing the **Start** key. Values that exceed the limits of the editable field (shown in the blue bar at the top of the screen) are automatically corrected to be within the limits upon accepting the value.



Physical Numeric Keypad

## Entering Letters

There are some editable fields that are used to create names, such as the **Save Run Settings** screen. While there are no letters indicated on the physical numeric keypad, letters can be entered on the GUI numeric keypad or the physical numeric keypad using the lettering scheme

typically seen on phone keypads. The first press of a number key will enter the number in the field. Each subsequent quick press of the number key will cycle through the letters associated with that number. Once all the letters for that number have been cycled through, the next key press will start back over with the number again. Note that these key presses must be in rapid succession to cycle through the number and letters; any pause in key presses will cause the next key press to add a new character to the field. The clear key (C) or button acts as a delete or backspace key, which will remove the previous character.



Digital Numeric Keypad w/ Letters

## Mode Selection Screen

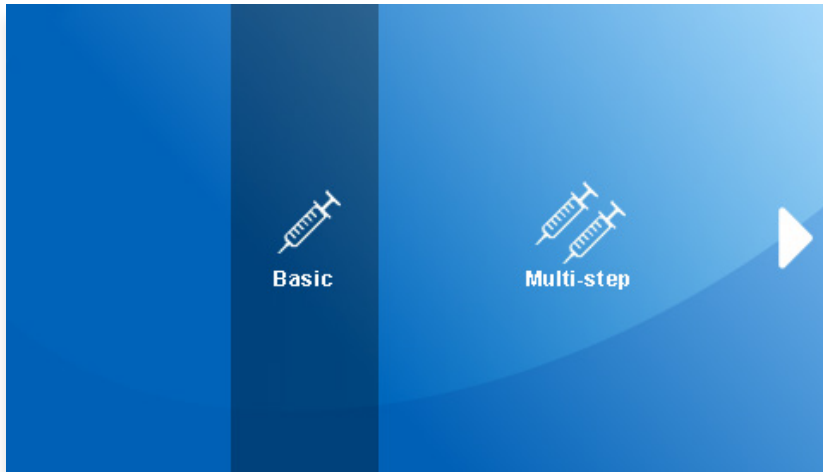

Mode Selection Screen 1

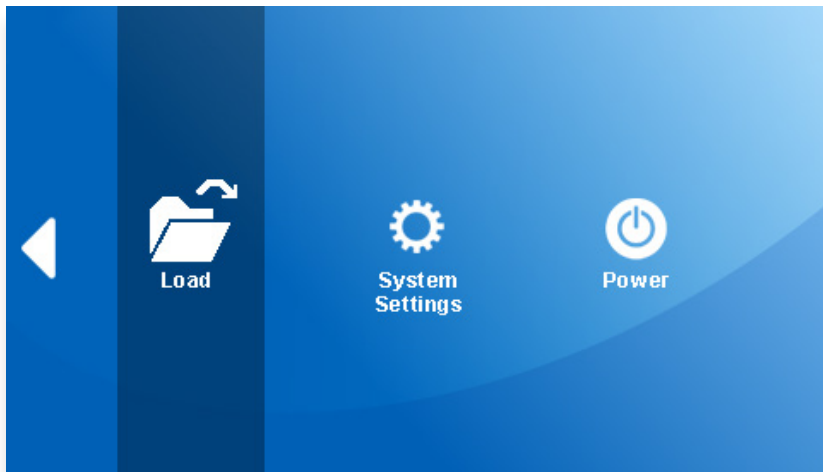

Mode Selection Screen 2

The **Mode Selection** screen is the top level menu for the Fusion series pumps. This screen allows users to select the Basic or Multi-Step modes, load a previously saved method, and adjust system settings or power settings.

The **Mode Selection** screen consists of two screens. Items on each screen can be tapped by touch to enter the selected option. To maneuver between the screens, the white triangular arrow on the edge of the screen can be tapped to go between the two screens. Users can also swipe a finger on the screen to switch between screens. Additionally, the navigation keypad can also be used to select an item, and the **ENTER** key is used to access the selected option.

For a description of the items listed in the **Mode Selection** screen, please refer to the associated section in this manual.

## Basic Mode

The Basic Mode screen displays the following parameters and controls:

- Syringe:** 23.04 mm (with Max Id: 40 and Min Id: 0.103 displayed at the top)
- Volume:** 1.2 ml
- Rate:** 3 ml/min
- Delay:** 0: 30 min
- Buttons:** Find Syringe, ← Infusion, Options

Basic Mode Screen

**Basic Mode** (or Single-Step Mode) is used for applications that do not require advanced automation, variable volume and rate settings, step looping, or ramping rates.

The **Basic Mode** screen can be reached by tapping on the Basic icon on the **Mode Selection** screen.

**Basic Mode** allows users to select the syringe being used, to set a valid volume and rate, and to choose whether to infuse or withdraw (Fusion 200 only).

The pump can only be started in **Basic Mode** while the **Basic Mode** screen is displayed.

## Syringe Selection

For every application, the first required step for setup is to select the inner diameter (ID) of the syringe(s) being used. This value is important for the syringe pump to accurately calculate the transfer rate and the total transferred volume for the liquid in the syringe. There are two approaches to entering this value: (1) enter a custom inner diameter or (2) use the built-in syringe library to import an inner diameter.

Entering a custom inner diameter (ID) is as simple as typing in the ID in millimeters in the **Syringe** editable field. The maximum and minimum values for the ID are displayed in the blue bar at the top of the screen while the **Syringe** editable field is selected. This value is also limited to only three decimal places, where any additional decimals or trailing zeroes are dropped. If the value of the Volume field is smaller/larger than the min/max volume allowed for the input inner diameter, the value in the Volume field will be adjusted to be within range. Otherwise, no changes to the volume will occur.

Tapping the **Find Syringe** button to the right of the **Syringe** editable field will open a new **Syringe Library** screen. Syringe manufacturers are found in the list on the left. Selecting a manufacturer will display all of the syringes available from that manufacturer in the list on the right. The list of syringes typically indicates the volume of the syringe first, followed by the inner diameter of the syringe. Both lists can be scrolled through by dragging a finger on the scroll bar; however, the easiest approach in this screen may be to use the navigation keypad to scroll through the lists. A list of the syringes in the library can be found in Appendix A.

The Syringe Library screen displays a list of syringes with the following details:

Manufacturer	Volume	Inner Diameter
AirTite		
Becton Dickinson		
Becton Dickinson		
Hamilton	25.00 ml	23.03 mm
JMC Air-Tite		
SGE	500.00 ul	3.26 mm
Nipro	100 ml	4.61 mm
Hoshi	2.50 ml	7.28 mm
Natsume	5.00 ml	10.30 mm
Terumo	10.00 ml	14.57 mm
Terumo	25.00 ml	23.03 mm

Syringe Library Screen



When a particular syringe is selected from the list on the right, an **Accept/Enter** button will appear next to the selected item. Tapping the **Accept/Enter** button (or pressing the Enter key on the navigation keypad) will import the inner diameter associated with the selected syringe and exit the **Syringe Library** screen.

Upon import of a syringe from the syringe library, the **Syringe** editable field will be updated to the new inner diameter, and the Volume editable field will be updated to the volume of the imported syringe. Please note that the volume units and values for the **Volume** and **Rate** fields may change to match the units of volume displayed for the syringe in the **Syringe Library**.

**Tip:**

Because changing the values of the syringe ID may possibly change the values and units for volume and rate, selecting a syringe or entering the syringe ID should always be the first step when setting up a run.

**Important Note:**

If more than one syringe will be used at the same time, it is recommended that all of the syringes be of the same inner diameter. Because Fusion pumps calculate the rate that the pushing block moves based on the input syringe inner diameter and flow rate, syringes with larger or smaller inner diameters will transfer more/less volume than indicated by the GUI.

## Volume

The **Volume** field represents the total volume of liquid that the pump will transfer (infusion or withdrawal) before stopping. The amount of time that the pump will run with the set target volume can be determined by dividing the volume by the flow rate.

The value entered can be any integer or decimal within the limits for the syringe. The min/max volume limits can be found in the blue bar at the top of the screen when the Volume field is selected. Any entered value beyond these limits will be automatically adjusted to the minimum or maximum limit, whichever is closer. The total number of decimal places is limited to five.

The volume can be stated in units of mL or  $\mu$ L. The units used for the volume are dependent upon the set units of volume for the flow rate in the **Options** screen.

To continuously run the pump and use the entire volume of the syringe, users can set the volume to the total volume of the syringe or to the maximum limit. However, users are strongly encouraged to set the safety collar/bar (see Adjusting the Safety Collar) so that the pump does not potentially ruin the syringe.

**Important Note:**

The maximum volume limit for a syringe assumes that the length of the syringe is the length of the pump. Therefore, this maximum volume limit is almost always larger than the actual volume the syringe can hold.

## Infusion/Withdrawal (Fusion 200 only)

The Fusion 200 is capable of both infusion and withdrawal. On Fusion 200 systems, an **Infusion/Withdrawal** toggle button should appear to the right of the Volume field. The text and arrow direction on the button indicates the mode that is currently set and direction that the pusher block will move upon starting the run. Tapping the button will switch between the two modes.

## Flow Rate

The **Flow Rate** field indicates how fast the pusher block will move. The amount of time that the pump will try to run can be determined by dividing the set volume by the flow rate.

The value entered can be any integer or decimal within the limits for the syringe. The min/max flow rate limits can be found in the blue bar at the top of the screen when the **Rate** field is selected. Any entered value beyond these limits will be automatically adjusted to the minimum or maximum limit, whichever is closer. The total number of decimal places is limited to five.

The rate can be stated with four different units: mL/min, mL/hr,  $\mu$ L/min, and  $\mu$ L/hr. Adjusting the units will affect the min/max limits for the **Rate** field. The units for rate can be set in **Options**.

### Caution:

Flow rate is often set for the needs of the experiment; however, users should be aware that setting high flow rates, especially for viscous fluids, may require high linear force beyond the limits of the pump which may cause the pump to stall out. Additionally, high flow rates can exert tremendous pressure within a syringe that may cause glass or plastic syringes to burst. In the case of high-pressure experiments, users should consider using Chemyx Stainless-Steel Syringes and the high-pressure Chemyx Nexus 6000 pump.

## Start-Time Delay

The **Delay** field represents the amount of time (in minutes and seconds) to delay starting the pump after pressing the **Start** button.

When entering this value with the numeric keypad, the decimal key is used to indicate the separation between minutes and seconds. The first two values entered will be minutes unless a zero is the first value or a decimal is entered, the occurrence of which causes the next values to be in seconds.

### Example:

To set a delay of 1 min and 30 seconds, press the "1" key, then the decimal key, and finally the "3" and "0" keys. To set a delay of 45 seconds, press the decimal key, then the "4" and "5" keys.

To remove the delay, simply press the clear key (**C**) or set the time to zero.

## Options

The Fusion 200 is capable of both infusion and withdrawal. On Fusion 200 systems, an Infusion/Withdrawal toggle button should appear to the right of the Volume field. The text and arrow direction on the button indicates the mode that is currently set and direction that the pusher block will move upon starting the run. Tapping the button will switch between the two modes.

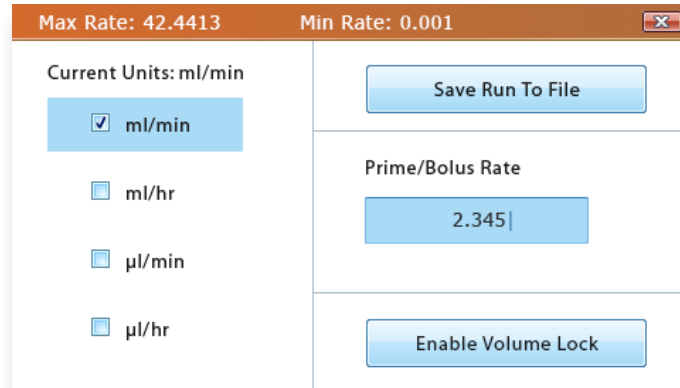

Save Run Settings screen

## Flow-Rate Units

The flow-rate units determine which units of volume and time will be used for the **Volume** and **Rate** fields. It also determines the units for the **Priming/Bolus Rate**. This setting in **Basic Mode** also changes the units for **Multi-Step Mode**.

Note:

Even if the units have changed, the values within the Volume and Rate fields will not change, which will result in significant changes in the flow rate and volume transferred. Additionally, the min/max limits for these fields will also be changed, so if the current values for volume and rate exceed the new limits, they will be adjusted to be within those set limits.

## Saving Run Parameters

All of the current settings in **Basic Mode** can be saved for future use. The name can be any combination of the alphanumeric characters, up to a max of eight characters. If a name already exists in memory, the user will be asked to overwrite the previous method. If the user enters a unique name or selects “Yes” to the overwrite question, the settings will be saved to the overwrite question, the settings will be saved to the pump, and the screen will return to the **Basic Mode** main screen. If the user selects “No” to the overwrite question, the screen will return to the **Save As** name field for the user to edit the name. The Fusion series pumps can store up to a maximum of 20 different methods.

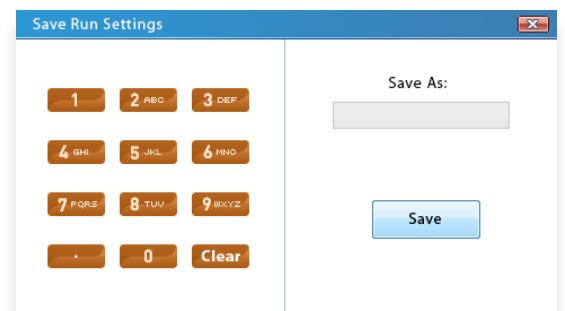

Save Run Settings screen

## Options

Priming allows for the user to temporarily run the pump to remove dead/empty volume in the syringe needle or tubing prior to running the experiment.

The rate at which priming occurs is set in the **Priming/Bolus Rate** field. The value entered can be any integer or decimal within the limits for the syringe. The min/max flow rate limits can be found in the orange bar at the top of the screen when the **Priming/Bolus Rate** field is selected. Any entered value beyond these limits will be automatically adjusted to the minimum or maximum limit, whichever is closer. The total number of decimal places is limited to four.

The units for the **Priming/Bolus Rate** are determined by the **Flow-Rate** Units setting in Options. Adjusting the units will affect the min/max limits for the **Priming/Bolus Rate** field.

To enter priming mode on Fusion pumps, press and hold the **Start** key while in the main screen of **Basic Mode**.

Caution:

Flow rate is often set for the needs of the experiment; however, users should be aware that setting high flow rates, especially for viscous fluids, may require high linear force beyond the limits of the pump which may cause the pump to stall out. Additionally, high flow rates can exert tremendous pressure within a syringe that may cause glass or plastic syringes to burst. In the case of high-pressure experiments, users should consider using Chemyx Stainless-Steel Syringes and the high-pressure Chemyx Nexus 6000 pump.

## Enable Volume Lock

This function has been deprecated and is no longer supported.

## Multi-Step Mode

**Multi-Step Mode** is used for more advanced applications that may require numerous steps, multiple different volume and rate settings, step looping, or ramping rates.

The **Multi-Step Mode** screen can be reached by tapping on the Multi-Step icon on the **Mode Selection** screen.

The pump can only be started in **Multi-Step Mode** when the **Multi-Step Mode** screen is showing. This also holds true for computer control of the pump through a serial connection; the pump must be switched to the **Multi-Step Mode** screen on the pump interface first.

### Setup

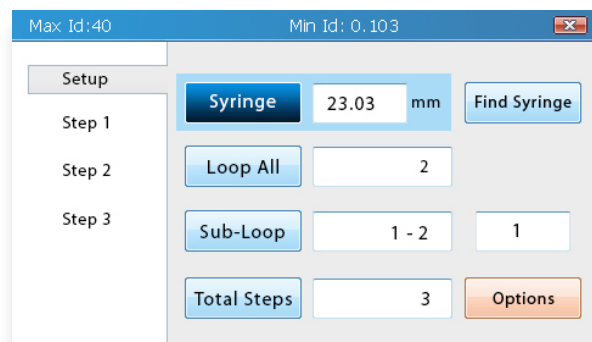

Step	Configuration
Setup	Syringe: 23.03 mm, Find Syringe
Step 1	
Step 2	Loop All: 2
Step 3	Sub-Loop: 1 - 2, 1
	Total Steps: 3, Options

Multi-Step Mode Setup screen

In **Multi-Step Mode**, the left side of the screen shows a list of selectable items. The first (topmost) item in this list is **Setup**. Tapping Setup will take users to the **Multi-Step Method Setup screen**, where the syringe inner diameter (ID), total number of steps, number of loops, and flow-rate units can be set.

### Syringe Selection

Syringe selection for **Multi-Step Mode** works in much the same manner as seen in **Basic Mode**.

Changes in the syringe ID will affect the min/max values for the Volume field in all steps. However, unlike **Basic Mode**, importing a syringe from the Syringe Library will not change the volumes in each step to the volume of the syringe unless they exceed the volume limits of the new syringe. All values in each step that are outside these new limits will be adjusted to be within the limits.

**Tip:**

Because changing the values of the syringe ID may possibly change the values and units for volume and rate, selecting a syringe or entering the syringe ID should always be the first step when setting up a run.

## Total Steps

The **Total Steps** field determines how many steps will occur in the method. Each step has independent values for **Volume**, **Rate**, **Delay**, and **Infusion/Withdrawal**. Upon entering the number of steps, the list on the left of the screen will update to show all of the steps. Each one of the steps will have their own set of parameters that will need to be set (see Step Parameters).

A minimum of 1 and maximum of 99 steps can be entered as a method.

Adding steps is accomplished by increasing the **Total Steps**, which will add the new steps at the end of the list. Decreasing the **Total Steps** will remove steps from the end of the list. In either case, the values in the Step Parameters for each existing step does not change upon the addition or deletion of steps.

In the case that the number of steps in the list on the left side of the screen exceeds the available space on the screen, a blue triangle arrow will appear below the list indicating that it can scroll. This list can scroll two ways: (1) the user can drag their finger up and down on the list to scroll the list and then tap on the item of interest; or (2) the user can use the up/down arrows in the navigation keypad to scroll through the items.

## Loop All

The **Loop All** field determines how many additional times the pump will perform all of the steps. This is the highest level loop and is the last loop to iterate after all the steps and step loops have completed.

### Example:

In a multi-step method of three steps (1, 2, 3) where the Loop All is set to "2". The method will run the following steps sequentially: 1, 2, 3, 1, 2, 3, 1, 2, 3. As shown, the method will loop through all three of the steps two additional times.

The **Loop All** field takes any integer from 0 to 99. A value of 0 indicates that the method will run through the entirety of steps only once. Any value above 0 represents additional times to run all of the steps.

In the pump running screen, the current loop number and total number of loops are indicated in the blue bar at the top of the screen.

## Sub-Loops

This function has been deprecated and is not supported. *Please leave these fields empty.*

## Flow-Rate Units

Tapping the **Options** button opens a screen that allows flow-rate units to be set. The flow-rate unit determines which unit of volume and time will be used for the **Volume** and **Rate** fields for all of the steps. This setting in Multi-Step Mode also changes the units for Basic Mode.

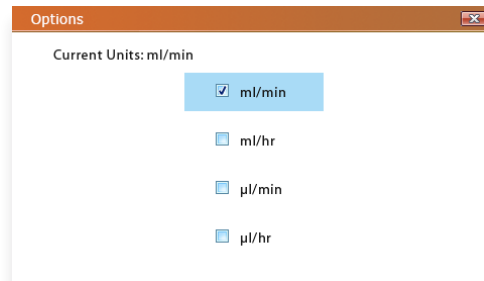

Multi-Step Mode Options screen

### Important Note:

Even if the units have changed, the values within the Volume and Rate fields will not change, which will result in significant changes in the flow rate and volume transferred. Additionally, the min/max limits for these fields will also change, so if the current values for volume and rate exceed the new limits, they will be adjusted to be within the limits.

## Step Parameters

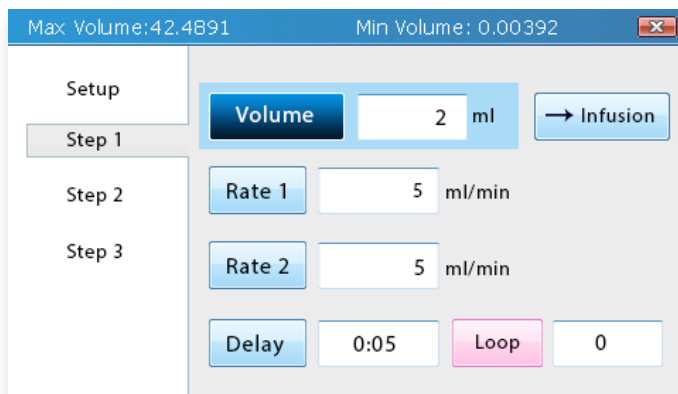

Step Parameters screen

Every step in the multi-step method will have a selectable entry in the list on the left side of the screen after **Setup**. Tapping the step will bring users to the **Step Parameters** screen for that step. In this screen, the transfer volume, flow rate, time start delay, and number of loops can be set.

## Volume

The **Volume** field represents the total volume of liquid that the pump will attempt to transfer (infusion or withdrawal) before completing the step. The amount of time that the pump will attempt to run with the set volume can be determined by dividing the volume by the flow rate (as long as the flow rate is static).

The value entered can be any integer or decimal within the limits for the syringe. The min/max volume limits can be found in the blue bar at the top of the screen when the Volume field is selected. Any entered value beyond these limits will be automatically adjusted to the minimum or maximum limit, whichever is closer. The total number of decimal places is limited to five.

The volume can be stated in units of mL or  $\mu$ L. The units used for the volume are dependent upon the set units of volume for the flow rate in the **Options** screen during the multi-step setup.

To continuously run the pump and use the entire volume of the syringe, users can set the volume to the total volume of the syringe or to the maximum limit. However, users are strongly encouraged to set the safety collar/bar (see Adjusting the Safety Collar) so that the pump does not potentially ruin the syringe.

### Important Note:

Even if the units have changed, the values within the Volume and Rate fields will not change, which will result in significant changes in the flow rate and volume transferred. Additionally, the min/max limits for these fields will also change, so if the current values for volume and rate exceed the new limits, they will be adjusted to be within the limits.

## Infusion/Withdrawal (Fusion 200 only)

The Fusion 200 is capable of both infusion and withdrawal on each step. On Fusion 200 systems, an **Infusion/Withdrawal** toggle button will appear to the right of the Volume field. The text and arrow direction on the button indicates the mode that is currently set and the direction that the pusher block will move upon starting the run. Tapping the button will switch between the two modes.



## Flow Rate

The **Flow Rate** fields indicates how fast the pusher block will move. The amount of time that the pump will run can be determined by dividing the set volume by the flow rate.

In **Multi-Step Mode**, the flow rate during the step can be static or variable, which is set by the two rate fields (**Rate 1** and **Rate 2**) in each step. **Rate 1** represents the flow rate when the step starts while **Rate 2** represents the flow rate when the step ends (see Static Flow Rate and Variable Flow Rate for more details).

For each field, the value entered can be any integer or decimal within the limits for the syringe. The min/max flow rate limits can be found in the blue bar at the top of the screen when the Rate field is selected. Any entered value beyond these limits will be automatically adjusted to the minimum or maximum limit, whichever is closer. The total number of decimal places is limited to five.

The rate can be stated with four different units: mL/min, mL/hr,  $\mu$ L/min, and  $\mu$ L/hr. Adjusting the units will affect the min/max limits for the Rate field. The units for rate can be set in Options during the multi-step setup.

### Caution:

Flow rate is often set for the needs of the experiment; however, users should be aware that setting high flow rates, especially for viscous fluids, may require high linear force beyond the limits of the pump which may cause the pump to stall out. Additionally, high flow rates can exert tremendous pressure within a syringe that may cause glass or plastic syringes to burst. In the case of high-pressure experiments, users should consider using Chemyx Stainless-Steel Syringes and the high-pressure Chemyx Nexus 6000 pump.

## Static Flow Rate

A static flow rate during a step means that the flow rate does not change during the step. Static flow rates are set simply by editing the **Rate 1** field. Any edit of the **Rate 1** field will automatically change **Rate 2** to be equivalent. Whenever **Rate 1** and **Rate 2** are equivalent, the flow rate will be static.

## Variable Flow Rate

A variable flow rate during a step means that the flow rate will change during the step. Variable flow rates are set simply by editing the **Rate 2** field to a value that is different from **Rate 1**. During a step, the flow rate will start at **Rate 1** and will linearly increase or decrease such that **Rate 2** is reached at the end of the step's run.

## Start-Time Delay

The Delay field represents the amount of time (in minutes and seconds) to delay starting the pump after the current step begins.

When entering this value with the numeric keypad, the decimal key is used to indicate the separation between minutes and seconds. The first two values entered will be in minutes unless a zero is the first value or a decimal is entered, the occurrence of which causes the next values to be in seconds.

**Example:**

To set a delay of 1 min and 30 seconds, press the "1" key, then the decimal key, and finally the "3" and "0" keys. To set a delay of 45 seconds, press the decimal key, then the "4" and "5" keys.

To remove the delay, simply press the clear key (C) or set the time to zero.

## Step Loop

The **Step Loop** field determines how many additional times to sequentially perform the particular step. This is the lowest-level loop that iterates whenever that particular step is reached and completed.

**Example:**

In a multi-step method of five steps (1, 2, 3, 4, 5) where Step 4 has a Step Loop of "2". The method will run the following steps sequentially: 1, 2, 3, 4, 4, 4, 5. When the step loop is set to "2", Step 4 is repeated twice more. If the entire method also has a Loop All setting of "1", the method would run the following steps sequentially: 1, 2, 3, 4, 4, 4, 5, 1, 2, 3, 4, 4, 4, 5.

The **Step Loop** field takes any integer from 0 to 99. A value of 0 indicates that the method will run the step only once. Any value above zero represents additional times to run the step.

In the **Pump Running** screen, the number of remaining loops of the current step appears on the right, next to the repeat icon.

# Pump Control

The pump's actions are controlled by the **Stop**, **Pause**, and **Start** keys on the front. In order to start a run, the screen should be showing either the **Basic Mode** (for basic runs) or **Multi-Step Mode** (for multi-step runs) main screens. Pressing the Start key in either other these screens will start a run with the currently set parameters.

Amount	Functions
Start	<p>Pressing the <b>Start</b> button once will start a new run with the currently displayed parameters or resume a paused run. This button is only functional when a run is currently paused or when the display is showing the <b>Basic Mode</b> or <b>Multi-Step Mode</b> screens that show the current parameters.</p> <p>Pressing the <b>Start</b> button while a delay countdown is occurring will immediately skip the remaining delay time and start the run/step.</p> <p>Pressing and holding the Start button will begin priming, where the pump will continuously run at the Prime/Bolus Rate as long as the button is being pressed. The Prime/Bolus Rate is set in Basic Mode &gt; Options. Priming is only available in Basic Mode.</p> <p>The green LED light on the Start button will be on while the pump is running.</p>
Pause	<p>While the pump is running, pressing the <b>Pause</b> button will pause the current run. Pausing allows the pump to continue the same run from the point when the pause occurred.</p> <p>The yellow LED light on the Pause button will be on when the current run has been paused.</p>
Stop	<p>During a run, pressing the <b>Stop</b> button will immediately stop the run, and return the display to the <b>Basic Mode</b> or <b>Multi-Step Mode</b> screen.</p> <p>While outside of an active run, pressing the Stop button will exit the current screen. This result is the same as activating the "X" button in the top right corner of the screen by touch or navigational keypad.</p> <p>The red LED light on the <b>Stop</b> button will be on whenever the pump is neither actively running nor paused. The light will also be on for active runs that are currently in a delay before starting a step.</p> <p>The red LED light will blink if the pump has stalled.</p>

Upon starting a pump run, the screen will switch to the **System Status** screen. There are two different versions of this screen depending upon whether the pump was started in **Basic Mode** or **Multi-Step Mode**.

## Run Status

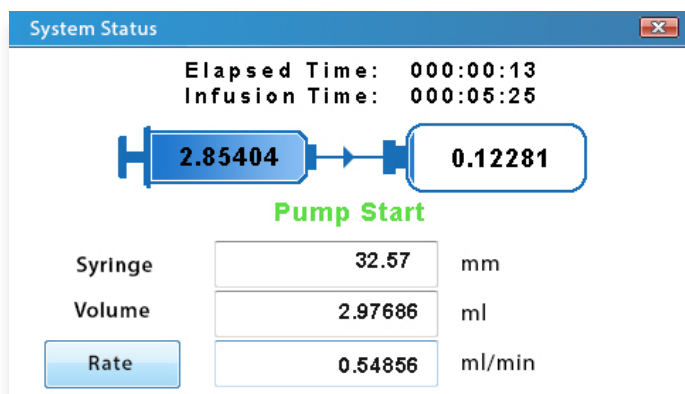

Basic Mode System Status screen

The **System Status** screen for **Basic Mode** highlights the current activity of the pump during a run.

The **Elapsed Time** field indicates how much time has passed since the pump has started physically running, not including any start-time delay. The **Infusion Time** field shows the calculated total time for the current run to finish, barring any pause or stall in the instrument.

The two rectangular blocks on the screen illustrate the transfer of volume during the run. The left rectangle represents the volume in the syringe while the right rectangle represents the volume transferred in or out of the syringe. While the pump is running, a small arrow will appear between the two rectangles indicating the direction of flow. Depending upon the direction of the arrow, the numbers within each rectangle will change as volume is transferred.

The colored text directly under the volume transfer graphic indicates the current status of the pump: green - running; yellow - paused or delayed; and red - stopped or stalled.

The **Syringe**, **Volume**, and **Rate** fields indicate the parameters that were set for the currently running method in the **Basic Mode** main screen.

Tapping the **Rate Adjust** button allows users to change the flow rate of the pump in the middle of the run.

## Load Run

The **Load Run** screen allows users to recall **Basic Mode** methods that were saved in the **Options** screen.

The **Load Run** screen can be reached by tapping on the Load folder icon on the **Mode Selection** screen.

The left side of the screen shows a list of all the saved methods (a maximum of 20). Tapping and selecting a method in this list will display the parameters for the method in the top right of the screen.

To load a method, select the method and then press the **Load** button on the bottom right of the screen. The screen will immediately change to the **Basic Mode** main screen with all of the parameters of the saved method.

To delete a method, select the method and then press the **Delete** button on the right side of the screen. A pop-up screen will ask the user to confirm deletion, and upon pressing **Yes**, the method will be removed from the system's memory and from the list on the left.

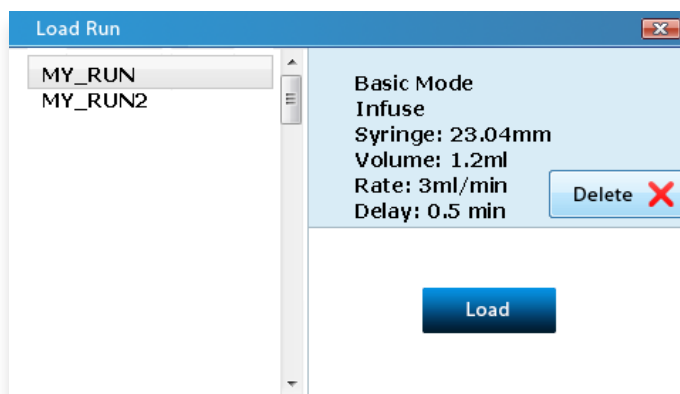

Basic Mode System Status screen

## System Settings

The **System Settings** screen can be reached by tapping on the Settings icon on the **Mode Selection** screen.

### Touchscreen Toggle

Pressing the **Touch On/Off** toggle button will enable/disable the touchscreen capabilities of the LCD display, respectively. If the touchscreen is off, only the physical arrow keys can be used to select items on the screen. Conversely, the **Touch On/Off** toggle button is always selectable by touch regardless of the current state of the toggle, so that you may return to using the touchscreen capabilities.

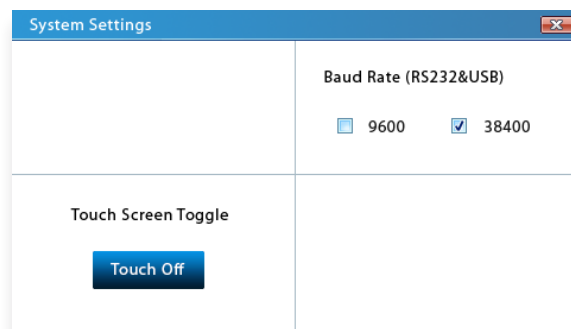

System Settings screen

## Baud Rate

The baud rate is the rate at which information is transferred through the serial connection. This rate is often limited by the type of serial connection used.

The Fusion Series pumps provide two possible baud rates: 9600 and 38400.

Serial connections using the USB-B port on the back of the pump should use the faster baud rate of 38400.

Serial connections using the DB9 port on the back of the pump will need to use the slower baud rate of 9600.

See Pump Control by Computer for more information.

# Power Settings

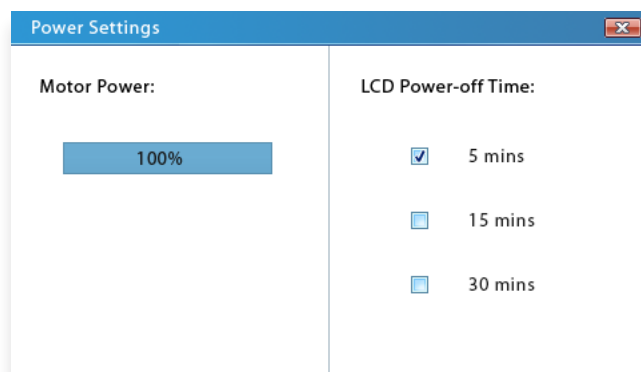

Power Settings screen

The **Power Settings** screen can be reached by tapping on the Power icon on the **Mode Selection** screen.

## Motor Power

The Fusion Series pumps can generate up to a maximum of 50 lbs (35 lbs for the Fusion 100) of linear force. Some syringes made of more fragile materials may not be able to withstand the full linear force of the pump. On the Fusion Series pumps, the motor power, and thus the linear force, can be decreased in the **Power Settings** screen.

To adjust this setting by touch, tap the section of the percentage bar that represents the desired motor power percentage (0% on far left and 100% on far right). To more precisely adjust the percentage, users should slowly drag their finger over the percentage bar.

To adjust this setting using the keypad, select the motor-power percentage bar with the navigational keypad or by touch. The percentage bar should be blue in color when selected. Press the clear key ("C" on the numpad) to clear the current value, and then use the numeric keypad to type in the desired percentage; the percentage bar will update as values are added.

### Important Note:

Even if the units have changed, the values within the Volume and Rate fields will not change, which will result in significant changes in the flow rate and volume transferred. Additionally, the min/max limits for these fields will also change, so if the current values for volume and rate exceed the new limits, they will be adjusted to be within the limits.

## LCD Power-Off Time

This setting sets the amount of time until the LCD display goes to sleep after the last interaction with the pump controls. When the display goes to sleep, the pump is still on. It will continue to run the current method and is able to receive commands via computer connection.

## Pump Control by Computer

The Fusion Series syringe pumps can be controlled with an external computer using an RS232 serial connection.

### Cable Requirements

Two types of connections are available for external computer control: DB9 and USB, cables for each are available for purchase through Chemyx (call 1-281-277-5499 or visit [www.chemyx.com/contact-us](http://www.chemyx.com/contact-us)).



DB9 Serial Cable (Male-to-Female)



USB-A to USB-B cable

For the DB9 serial connection, a Male-to-Female DB9 cable must be used. Do not use any “null modem,” “crossover,” or “crossed-over” cables. The cable can be of any length up to 50 ft; however, the speed of the connection is often detrimentally affected at lengths over 15 ft.

For a USB serial connection, a USB-A to USB-B cable should be used. The maximum possible length of a single USB cable is 15 ft; however, USB cables should be less than 10 ft for optimum performance. Multiple USB cables can be chained together to make a longer connection as long as the hub connecting each individual cable is connected to a power supply.

A USB-to-DB9 serial adapter can be used to connect a DB9 serial connection to the USB port on a computer.

All of these connections require the proper drivers to be installed on the computer. Typically, most current operating systems already contain drivers for the USB serial connection. They may also already have drivers for the DB9 serial connection. USB-to-DB9 adapters typically need to have a USB-to-serial driver installed. For more information on downloading and installing drivers please visit [www.chemyx.com/support](http://www.chemyx.com/support).

### Connecting

Most computer operating systems (e.g., Windows, macOS, Linux, etc.) have built-in terminal programs that can be used to type in the commands that run the pump. On Windows XP and earlier, HyperTerminal can be used to control to the pump. On macOS and Linux, the screen command in Terminal can also be used to control the pump. There are also numerous third-party programs for serial connections that exist for each operating system that may be easier to use and provide more features. A third-party program will be necessary to connect with computers running Windows Vista and later.

For tips on operating the built-in terminal programs and information on available third-party programs, please visit [www.chemyx.com/support](http://www.chemyx.com/support).



## COM Port Settings

Regardless of the operating system being used, the terminal program controlling the serial connection should use the following connection settings:

Baud Rate	9600 or 38400
Data Bits	8
Parity	None
Stop Bits	1
Flow Control	None

The baud rate setting for the serial connection must match the baud rate set in the pump settings GUI (See Baud Rate in System Settings).

Generally, the pump should be set to use the higher baud rate (38400) if a USB-only connection is used. However, if a DB9-only or USB-to-DB9 connection is used, the baud rate must be set to 9600.

Typically, if the baud rate is not set correctly, there will be garbled or no response to any commands

# Com

Regardless of the operating system being used, the terminal program controlling the serial connection should use the following connection settings:

Command	Description
help	Displays a list of available commands.
start	Starts the pump with the currently set parameters. The parameters that will run depend upon which mode ( <b>Basic Mode</b> or <b>Multi-Step Mode</b> ) the pump touchscreen is showing.
pause	Pauses the current pump run. The run can be resumed from this point using the <i>start</i> command.
stop	Ends the current run. The run cannot be resumed and can only be restarted from the beginning.
set diameter X	<p>Sets the inner diameter (ID) of the syringe in millimeters.</p> <p>This setting simultaneously affects the syringe ID used in both <b>Basic Mode</b> and <b>Multi-Step Mode</b> settings, which will also affect the volume and rate parameters in both modes.</p> <p>X can be an integer or decimal (up to three decimal places) from 0.103 mm to 40.000 mm.</p> <p><b>Example</b> <code>set diameter 11.73</code></p> <p>Returns the diameter.</p>
set units X	<p>Sets the units used for the rate of infusion/withdrawal. This parameter also sets the units for transfer volume, where the transfer volume unit will be the same as the volume unit used in the rate.</p> <p>This setting simultaneously changes the units used in both <b>Basic Mode</b> and <b>Multi-Step Mode</b> settings.</p> <p>X can be an integer from 0 to 3. Each integer represents a specific rate unit.</p> <p>0 = mL/min 1 = mL/hr 2 = <math>\mu</math>L/min 3 = <math>\mu</math>L/hr</p> <p><b>Example</b> <code>set units 2</code></p> <p>Returns the integer corresponding to the set rate unit.</p>

Command	Description
<p>set volume X,X,X,...</p>	<p>Sets the transfer volume. The pump will run until the volume infused or withdrawn equals this volume. This command also sets whether the pump is infusing or withdrawing (Fusion 200 only) and the number of steps used in Multi-Step Mode.</p> <p>X must be an integer or decimal (up to five decimal places) within the volume limits for the syringe (See read limit parameter command). A negative sign can be added in front of any value to indicate a switch to withdrawal mode (Fusion 200 only).</p> <p>For Basic Mode, only one value is required. Entering only one value will automatically switch the pump to Basic Mode.</p> <p><b>Example</b> set volume 25.0</p> <p>To set volumes in Multi-Step Mode, the pump must be manually switched to Multi-Step Mode on the pump. For each step, a value must be entered, separated by commas and no spaces. The number of steps will be automatically adjusted to the number of values entered (i.e., entering only three values will change the number of steps to three).</p> <p><b>Example</b> set volume 3,-2,4</p> <p>Returns the transfer volume, transfer rate, and transfer time (in Basic Mode).</p> <p>Returns only the transfer volumes (in Multi-Step Mode).</p>
<p>set time X,X,X,...</p>	<p>Sets the target time for a pump run. This will adjust the transfer rate so that the run will last for the input time. The target volume will remain the same. This command also sets the number of steps used in Multi-Step Mode.</p> <p>X must be an integer or decimal (up to five decimal places). The resulting transfer rate must be within the rate limits for the syringe (See read limit parameter command).</p> <p>For Basic Mode, only one value[ is required. Entering only one value will automatically switch the pump to Basic Mode.</p> <p><b>Example</b> set time 1.0</p> <p>To set target times in Multi-Step Mode, the pump must be manually switched to Multi-Step Mode on the pump. For each step, a value must be entered, separated by commas and no spaces. The number of steps will be automatically adjusted to the number of values entered (i.e., entering only three values will change the number of steps to three).</p> <p><b>Example</b> set time 1.0,0.5,1.3</p> <p>Returns target time and rate (in Basic Mode).</p> <p>Returns no values (in Multi-Step Mode).</p>

Command	Description
<p>set rate X,X,X,...</p>	<p>Sets the transfer rate for infusion/withdrawal.</p> <p>X must be an integer or decimal (up to five decimal places) within the rate limits for the syringe (See read limit parameter command).</p> <p>For Basic Mode, only one value is required.</p> <p><b>Example</b>  <pre>set rate 1.0</pre></p> <p>To set rates in Multi-Step Mode, the pump must be manually switched to Multi-Step Mode on the pump. For each step, a value must be entered, separated by commas and no spaces.</p> <p><b>Example</b>  <pre>set rate 1.0,0.5,1.3</pre></p> <p>If the number of values is less than the number of steps, the remaining steps will gain the same rate value as the last entered value. Any extra values beyond the number of steps will be truncated.</p> <p>Variable rates may also be set in Multi-Step Mode. Rate 1 and Rate 2 for each step can be set using a backslash. Each step is still separated by a comma.</p> <p><b>Example</b>  <pre>set rate 0.5/1.0,0.5/1.0,1.3</pre></p> <p>Returns the flow rate and transfer time (in Basic Mode).</p> <p>Returns the flow rate 1 and flow rate 2 for each step (in Multi-Step Mode).</p>

Command	Description
set delay X,X,X,...	<p>Sets the start time delay (in minutes) prior to each step of a pump run. Upon starting the a step, the pump will wait until the delay time elapses before starting to transfer volume.</p> <p>X must be an integer or decimal (up to five decimal places) within the rate limits for the syringe (See read limit parameter command).</p> <p>For Basic Mode, only one value is required. Entering only one value will automatically switch the pump to Basic Mode.</p> <p><b>Example</b>  <pre>set delay 1.0</pre></p> <p>To set rates in Multi-Step Mode, the pump must be manually switched to Multi-Step Mode on the pump. For each step of Multi-Step Mode, a value must be entered, separated by commas and no spaces.</p> <p><b>Example</b>  <pre>set delay 1.0,0.5,1.3</pre></p> <p>If the number of values is less than the number of steps, the remaining steps will gain the same delay value as the last entered value. Any extra values beyond the number of steps will be truncated.</p> <p>Returns the delay time (in Basic Mode).</p> <p>Returns the delay time for each step (in Multi-Step Mode).</p>
read limit parameter	<p>Returns the min/max values that can be set for transfer volume and transfer rate. The returned values are dependent on the syringe inner diameter (ID). The transfer volume limits are typically greater than the maximum volume of the syringe being used.</p> <p>Returns: max rate, min rate, max volume, min volume</p>
dispensed volume	<p>Returns the transferred volume for the current run/step. If no run has started, returns the transferred volume for the last run/step.</p>
elapsed time	<p>Returns the elapsed time (in minutes) for the current run/step. If no run has started, returns the elapsed time for the last run/step. Elapsed time does not include any delay time.</p>
view parameter	<p>Returns the currently set parameters (Basic Mode only).</p> <p>Returns: rate units, syringe inner diameter, transfer rate, priming rate, time (in whole number minutes), transfer volume, time delay (in whole number minutes)</p>

Command	Description
status	<p>Returns the current status of the pump. The returned integer correlates to the status of the pump.</p> <p>0: Pump stopped  1: Pump running  2: Pump paused  3: Pump delayed  4: Pump stalled</p> <p>Returns: integer that represents the current status of the pump.</p>
hexw2XXXXXX start	<p>Sets multiple parameters in one command (Basic Mode only).</p> <p>X variables in order:  units: see set units command  transfer mode: 0-infusion, 1-withdrawal  syringe ID: see set diameter command  transfer volume: see set volume command; no negatives  transfer rate: see set rate command  start time delay: see set delay command</p> <p><b>Example</b>  The following example shows the command using these parameters:  units = mL/min; transfer mode = withdrawal; diameter = 23.05 mm;  volume = 1.2 mL; rate = 3.0 mL/min; delay = 30 sec (0.5 min)  hexw2 0 1 23.04 1.2 3.0 0.5</p> <p>A start command can be added after the six parameters to immediately start the run with the new parameters.</p> <p><b>Example</b>  hexw2 0 1 23.04 1.2 3.0 0.5 start</p> <p>All six parameters do not need to be entered; however, all parameters up to the parameter(s) of interest must be also be included. The other parameters not entered will remain as they are currently set.</p> <p><b>Example</b>  hexw2 0 1 23.04 2.4</p>
save setting	Deprecated command.

Command	Description
set primerate X	<p>Sets the priming/bolus rate (Basic Mode only).</p> <p>X must be an integer or decimal (up to five decimal places) within the rate limits for the syringe (See read limit parameter command).</p> <p>Only one value is required.</p> <p><b>Example</b>  <pre>set primerate 1.0</pre> </p> <p>Returns the priming/bolus rate (in Basic Mode).</p>
restart	<p>Powers off and then automatically powers on the pump.</p>

In some cases, depending on the software used to connect to the pump, each command may need to be followed by a line feed character such as “\n” or “\r” to execute. If a command does not appear to work, try adding “\r” or “\n” to the end of the line.

**Example**  

```
set units 1 \r
```

When the pump does not recognize a command, it will return text similar to the following:

**Example**  

```
Command not recognized-type in "help"
and press enter to see a command list.
```

## Chemyx Pump Controller Programs

In addition to the manual control of the pumps through a terminal, Chemyx provides pump controller programs as an unsupported open-source applications written in Python, a LabVIEW package, and a MATLAB package. More information on these tools can be found on the website at [www.chemyx.com/support](http://www.chemyx.com/support).

Chemyx provides free downloads for LabVIEW™ and MATLAB™ as a courtesy to our customers. This service is not supported by Chemyx, all customers are responsible for solving any technical issues related to LabView and MATLAB computer control.

# Pump Maintenance

## Lubricating the Pump

Pump lubrication is the most important part of regular pump maintenance. Proper lubrication ensures long service life, smooth flow performance, and protection against corrosive lab fumes. The pump may not be adequately cleaned and lubricated if the following occur: (1) grinding sounds are coming from the lead screw; (2) the block release button decouples under the load before the pump stalls; or (3) the pump stalls with increased frequency.

## Lubrication Instructions

1. Clean contact surfaces with a clean cloth. Remove any debris on the lead screw and the guide rods.
2. Apply lubricant along the length of the lead screw and the guide rods.
3. Press the block-release button and slide the pusher block to the left edge.
4. Run the pump end-to-end without a syringe to work the lubricant into the components.

Pump lubrication should be performed every three months.

## Approved Lubricants

- Engine/motor oil
- Silicone oil
- Machine oil
- Tooling oil or “WD-40”
- Lithium-based grease

Please contact Chemyx call +1 281-277-5499 or email us at [info@chemyx.com](mailto:info@chemyx.com) to confirm the safe use of a different lubricant.



# Pump Accessories

## Footswitch



Footswitch

The Chemyx Footswitch provides users the ability to start, pause, or stop the pump from a short distance with the tap of a foot.

### Footswitch

The Chemyx Footswitch for Fusion Series pumps has a USB-B cable that plugs into the TTL port on the back of the pump.

### Using the Footswitch

To use the Footswitch, the pump must be in either the Basic Mode or Multi-Step Mode screens. The basic commands are given by a certain number of clicks of the Footswitch.

A single click of the Footswitch will start the pump run or pause the pump run depending on whether the pump is currently running.

A quick double click of the Footswitch will completely stop the pump run.

## 10 Channel Syringe Rack (Fusion 200 Only)



10-Channel Syringe Rack

The Chemyx 10-Channel Syringe Rack for the Fusion 200 provides users with an expansion of the number of syringes that can be used simultaneously. The 10-channel syringe rack can accommodate up to 10 syringes with volumes from 1  $\mu$ L to 10 mL. The syringe rack can also be used with larger syringes (10 – 20 mL); however, only four such syringes will fit in the rack at the same time.

# Attaching the Rack

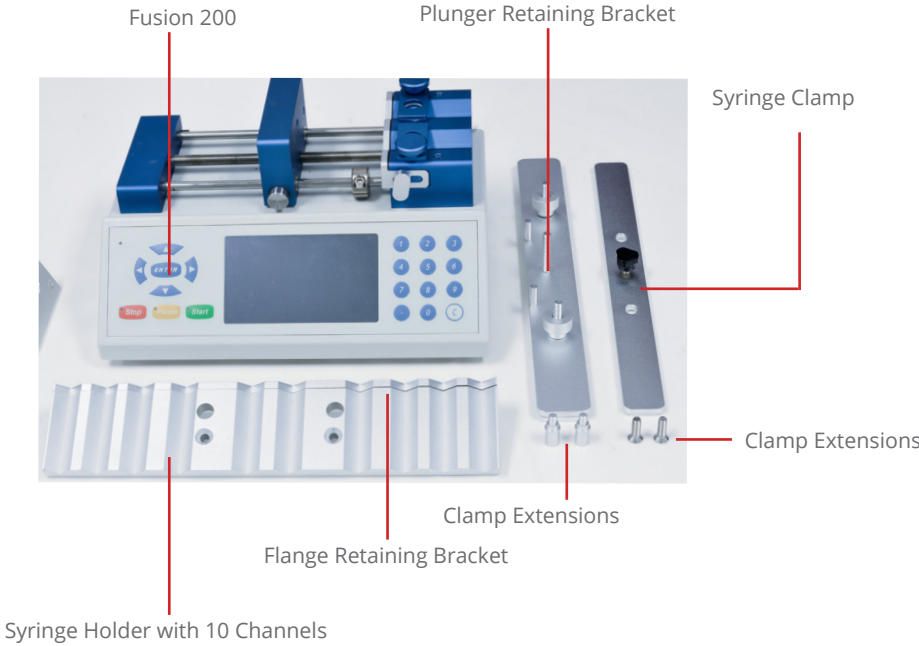

# Appendices

## Appendix A: Syringe Volume/Inner Diameter Reference

### Chemyx Stainless Steel

Size	Diameter Inner   Outer
6.00 mL	9.5 mm inner   13mm outer
20.00 mL	19.1 mm inner   23 mm outer
50.00 mL	28.6 mm inner   33 mm outer
100.00 mL	35 mm inner   38 mm outer
200.00 mL	44 mm inner   48 mm outer

### BD Glass

Size	Diameter
0.50 mL	4.64 mm
1.00 mL	4.64 mm
2.00 mL	8.93 mm
2.50 mL	8.66 mm
3.00 mL	8.93 mm
5.00 mL	11.73 mm
10.00 mL	14.68 mm
20.00 mL	19.60 mm
30.00 mL	22.70 mm
50.00 mL	28.03 mm
60.00 mL	28.60 mm

### BD Plastic

Size	Diameter
1.00 mL	4.64 mm
3.00 mL	4.64 mm
5.00 mL	12.07 mm
10.00 mL	14.50 mm
20.00 mL	19.13 mm
30.00 mL	21.69 mm
60.00 mL	26.72 mm

### Hamilton Glass

Size	Diameter
0.50 µL	0.10 mm
1.00 µL	0.15 mm
2.00 µL	0.21 mm
5.00 µL	0.33 mm
10.00 µL	0.48 mm
25.00 µL	0.73 mm
50.00 µL	1.03 mm
100.00 µL	1.46 mm
250.00 µL	2.30 mm
500.00 µL	3.26 mm
1.00 mL	4.61 mm
2.50 mL	7.28 mm
5.00 mL	10.30 mm
10.00 mL	14.57 mm
25.00 mL	23.03 mm
50.00 mL	32.57 mm

### Hoshi

Size	Diameter
1.00 mL	4.80 mm
1.00 mL	6.70 mm
2.00 mL	6.70 mm
2.00 mL	9.20 mm
3.00 mL	10.30 mm
5.00 mL	12.20 mm
10.00 mL	15.00 mm
20.00 mL	19.00 mm
30.00 mL	22.50 mm
50.00 mL	25.50 mm
100.00 mL	34.00 mm

## JMC Air-Tite Plastic

Size	Diameter
1.00 mL	4.66 mm
2.00 mL	6.90 mm
2.50 mL	9.10 mm
5.00 mL	12.62 mm
10.00 mL	14.34 mm
20.00 mL	19.68 mm
30.00 mL	22.44 mm
50.00 mL	28.80 mm
100.00 mL	36.68 mm

## Natsume

Size	Diameter
0.25 mL	2.60 mm
0.50 mL	3.20 mm
1.00 mL	4.30 mm
2.00 mL	6.30 mm
3.00 mL	7.30 mm
5.00 mL	9.50 mm

## Nipro

Size	Diameter
1.00 mL	4.71 mm
3.00 mL	9.50 mm
5.00 mL	12.91 mm
10.00 mL	15.40 mm
20.00 mL	19.30 mm
30.00 mL	23.40 mm
50.00 mL	29.00 mm

## Norm-Ject Plastic

Size	Diameter
1.00 mL	4.70 mm
2.50 mL	9.70 mm
5.00 mL	12.48 mm
10.00 mL	15.89 mm
20.00 mL	20.00 mm
30.00 mL	22.50 mm
50.00 mL	28.90 mm

## Popper & Sons Glass

Size	Diameter
0.25 mL	3.45 mm
0.50 mL	3.45 mm
1.00 mL	4.50 mm
2.00 mL	8.92 mm
3.00 mL	8.99 mm
5.00 mL	11.70 mm
10.00 mL	14.70 mm
20.00 mL	19.58 mm
30.00 mL	22.70 mm
50.00 mL	29.00 mm

## Ranfac

Size	Diameter
2.00 mL	9.12 mm
5.00 mL	12.34 mm
10.00 mL	14.55 mm
20.00 mL	19.86 mm
30.00 mL	23.20 mm
50.00 mL	27.60 mm

## SGE Glass

Size	Diameter
25.00 µL	0.73 mm
50.00 µL	1.03 mm
100.00 µL	1.46 mm
250.00 µL	2.30 mm
500.00 µL	3.26 mm
1.00 mL	4.61 mm
2.50 mL	7.28 mm
5.00 mL	10.30 mm
10.00 mL	14.57 mm

## Sherwood Plastic

Size	Diameter
1.00 mL	4.65 mm
3.00 mL	8.94 mm
6.00 mL	12.70 mm
12.00 mL	15.90 mm
20.00 mL	20.40 mm
35.00 mL	23.80 mm
50.00 mL	26.60 mm

## Terumo

Size	Diameter
1.00 mL	4.73 mm
3.00 mL	9.00 mm
5.00 mL	13.04 mm
10.00 mL	15.79 mm
20.00 mL	20.18 mm
30.00 mL	23.36 mm
60.00 mL	29.45 mm

## Terumo Japan

Size	Diameter
1.00 mL	4.73 mm
1.00 mL	6.50 mm
3.00 mL	8.65 mm
5.00 mL	13.00 mm
10.00 mL	15.80 mm
20.00 mL	20.15 mm
30.00 mL	23.10 mm
50.00 mL	29.10 mm

## Top

Size	Diameter
1.00 mL	4.70 mm
2.00 mL	6.40 mm
3.00 mL	9.30 mm
6.00 mL	13.10 mm
12.00 mL	15.40 mm
25.00 mL	21.00 mm
30.00 mL	23.00 mm
50.00 mL	29.00 mm

## Unimetrics

Size	Diameter
10.00 µL	0.46 mm
25.00 µL	0.73 mm
50.00 µL	1.03 mm
100.00 µL	1.46 mm
250.00 µL	2.30 mm
500.00 µL	3.26 mm
1000.00 µL	4.61 mm

## Kendall Monoject Plastic

Size	Diameter
1.00 mL	4.65 mm
3.00 mL	8.94 mm
6.00 mL	12.70 mm
12.00 mL	15.90 mm
20.00 mL	20.40 mm
35.00 mL	23.80 mm
60.00 mL	26.60 mm

## Appendix B: Available Parts

### Fusion Series Syringe Pumps

Item Description	Part Number
Fusion 100 Touch	07100
Fusion 200 Touch	07200
Fusion 400 Touch	07400

### Options and Accessories

Item Description	Part Number
Footswitch (w/ USB-B connection cable)	50002
DB9 Serial Cable (Male-to-Female)	50007
USB Serial Cable (USB-B-to-USB-A)	50017
10-Channel Syringe Rack (Fusion 200 only)	50003

### Stainless-Steel Syringes

Item Description	Part Number
Stainless-Steel Syringe (6 mL)	SS6
Stainless-Steel Syringe (20 mL)	SS20
Stainless-Steel Syringe (50 mL)	SS50
O-Ring Replacement 10-pack (6 mL)	CP6
O-Ring Replacement 10-pack (20 mL)	CP20
O-Ring Replacement 10-pack (50 mL)	CP50

## Appendix C: Contact Information

### **Chemyx Inc.**

10905 Cash Rd.

Stafford, TX 77477

Webpage: [www.chemyx.com](http://www.chemyx.com)

Contact Us: [info@chemyx.com](mailto:info@chemyx.com)

Phone: +1 281-277-5499

Fax: +1 281-277-0045

Office Hours: Monday–Friday, 8:30 am – 5 pm (Central Time)

For more articles and tutorial videos, visit: [www.chemyx.com/support](http://www.chemyx.com/support)

Follow Us

LinkedIn: [www.linkedin.com/company/chemyx](http://www.linkedin.com/company/chemyx)

Twitter: [www.twitter.com/chemyxinc](http://www.twitter.com/chemyxinc)