



# FUSION 4000-X

## USER MANUAL

### INTELLECTUAL PROPERTY

All Intellectual Properties, as defined below, owned by or which is otherwise the property of Chemyx Inc. or its suppliers relating to the Chemyx syringe pumps, including but not limited to, accessories, parts or software relating thereto (Chemyx Syringe Pumps), are proprietary to federal and state laws, and international treaty provisions. Intellectual Property includes but is not limited to, inventions (patentable or unpatentable), patents, trade secrets, copyrights, software, firmware, computer programs, and related documentation and other works of authorship. Moreover, you agree that you will not, and will not attempt to, modify, prepare derivative works of, reverse engineer, disassemble the Chemyx syringe pumps, decompile or otherwise attempt to create source code from the related software/firmware. No title to or ownership in Intellectual Property is transferred to you. All applicable rights of the Intellectual Property shall remain with Chemyx and its suppliers.

# Table of Contents

- Table of Contents.....2
- EU Declaration of Conformity (DoC).....4
- General Description.....5
- Product Overview.....6
  - Principle of Operation.....6
  - Controlled Elements.....7
- Specifications.....8
- Pump Setup.....9
- Powering On/Off the Pump.....9
  - Loading a Syringe.....10
  - Adjusting the Safety Nut/Stall Rod.....12
  - Pump Operation.....13
  - Mode Selection Screen.....14
- Basic Mode.....15
  - Syringe Selection.....15
  - Volume.....16
  - Infusion/Withdrawal.....17
  - Flow Rate.....17
  - Start-Time Delay.....18
  - Step Loop.....18
- Options.....19
- How To Use Cycle Mode.....20
- Multi-Step Mode.....21
  - Setup.....22
  - Syringe Selection.....21
  - Total Steps.....22
  - Loop All.....22
  - Flow-Rate Units.....23
- Step Parameters.....24
  - Volume.....24

# Table of Contents

- Pump Control.....25
- Run Status.....26
- Start Options.....27
- System Settings.....28
- Pump Control by Computer.....29
  - Cable Requirements.....29
  - Connecting.....29
  - COM Port Settings.....30
- Pump Commands.....31
- Chemyx Pump Controller Programs.....36
- Warranty and Repair Information.....37
  - Warranty Information.....37
  - Dead Pixel Policy.....38
  - Serial Numbers.....38
  - Calibrations.....38
- PumpMaintenance.....39
  - Lubricating the Pump.....39
  - Lubrication Instructions.....39
  - Approved Lubricants.....39
- Pump Accessories.....40
- Appendices.....42
  - AppendixA:SyringeVolume/DiameterReference.....42

# Declaration of Conformity

## EU Declaration of Conformity (DoC)

We:

Chemyx, Inc.  
10905 Cash Road  
Stafford, TX 77477  
(281) 277-5499  
info@chemyx.com

*Declare that the DoC is issued under the sole responsibility of the manufacture and belongs to the following product(s):*

**All Syringe Pump Model Names, including:**

- Fusion 100/Fusion 100-X
- Fusion 200/Fusion 200-X
- Fusion 4000/Fusion 4000- X
- Fusion 6000/Fusion 6000- X
- Nexus 3000
- Nexus 6000
- NanoJet StereoTaxic
- Fusion 101
- Fusion 100T2
- OEM

*The object of the declaration described above is in conformity with the relevant Union harmonization legislation:*

- EN 613326-1: 2013 Electrical Components for measurement, control, and laboratory use - EMC requirements - Part 1: General Requirements
- EN 61010-1: 2010 European Low Voltage Directive 2014/35/EU Safety requirements for electrical equipment for measurement, control, and laboratory use Part 1: General Requirements
- Directive 2011/65/EU of the European Parliament and of the Council of 8 June 2011 on the restriction of the use of certain hazardous substances in electrical and electronic equipment.
- Phthalates content-European Council Directive 2015/863 on revising the restricted substances in European Council Directive 2011/65/EU(RoSH)

The technical documentation required to demonstrate that the products meet the requirements of the LV and EMC directives has been compiled and is available for inspection by the relevant enforcement authorities.

Signature on behalf of manufacturer:

  
Jeff Wu, Senior Engineer, Chemyx, Inc.

Date:

August 15, 2021

**Attention!**

The attention of the specifier, purchaser, installer, or user is drawn to special measures and limitations to use which must be observed when these products are taken into service to maintain compliance with the above directives.

Details of these special measures and limitations to use are available on request,

# General Description

## Safety Information

Please read the following safety precautions to ensure personal safety and operational longevity of the Chemyx syringe pump. Chemyx is not responsible for the equipment if used in a manner not specified by the manufacturer; warranty coverage provided by the equipment may be dropped as a result.

**CHEMYX PRODUCTS ARE NOT APPROVED FOR CLINICAL USE ON HUMANS.**

### **USE PROPER POWER SUPPLY**

Chemyx is not responsible for the use of power supplies outside the stated electrical specifications or failure to switch the power converter from 220V to 110 V while in the 220V environment or vice versa.

### **GROUND PRODUCT**

The product should be properly grounded.

### **DO NOT OPEN THE PUMP**

Warranty coverage will be lost if the pump is opened without authorization from Chemyx. Do not touch any electrical connectors on or in the product.

### **DO NOT OPERATE WITH SUSPECTED FAILURES**

Even though the pump can operate at extremely fast speeds, the user must determine the proper flow rate for any given application. For instances, pumping at 90 mL/min using a 20-gauge needle will cause stalls and/or potential bursting of the syringe. Chemyx is not responsible for any damage that might result from situations similar to the example above.

### **PINCH HAZARD**

Do not place fingers between the pusher block and the end block while the pump is running.

### **OBSERVE ALL WARNING LABELS ON PRODUCT**

Read all labels on the product to ensure proper usage.

### **CHEMYX IS NOT RESPONSIBLE FOR SYRINGE DAMAGE**

The user is responsible for wetting ground glass syringes and setting and tightening the safety collar/bar appropriately.

# Product Overview



## FUSION 4000-X

The Chemyx Fusion product line serve a wide variety of applications. The Chemyx Fusion 4000-X is configured with two independently controlled syringe pump channels. The units' flexibility with syringe types and sizes and an advanced software interface make this high-pressure syringe pumps integrable into any operation or laboratory work flow. Thoroughly durable both inside and out, the Chemyx Fusion syringe pumps are designed to provide years of constant and reliable service.

## PRINCIPLE OF OPERATION

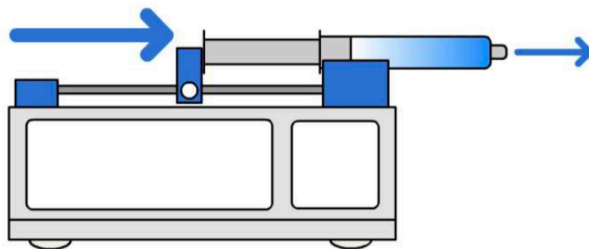

A syringe pump is a small, positive-displacement pump used to gradually transfer precise volumes of fluid. All Chemyx Fusion-series syringe pumps are driven via a stepper motor. This stepper motor precisely turns a lead screw that is threaded through a pusher block, which causes the pusher block to move. When the pump is in infusion mode, the pusher block pushes against the plunger of a secured syringe, causing the fluid to be ejected at an accurate and precise rate.

If the pump is capable of withdrawal, the plunger of the syringe is held by brackets on the pusher block. When the stepper motor turns in the opposite direction, the pusher block moves such that the syringe plunger is pulled, thus drawing fluid into the syringe.

## CONTROLS

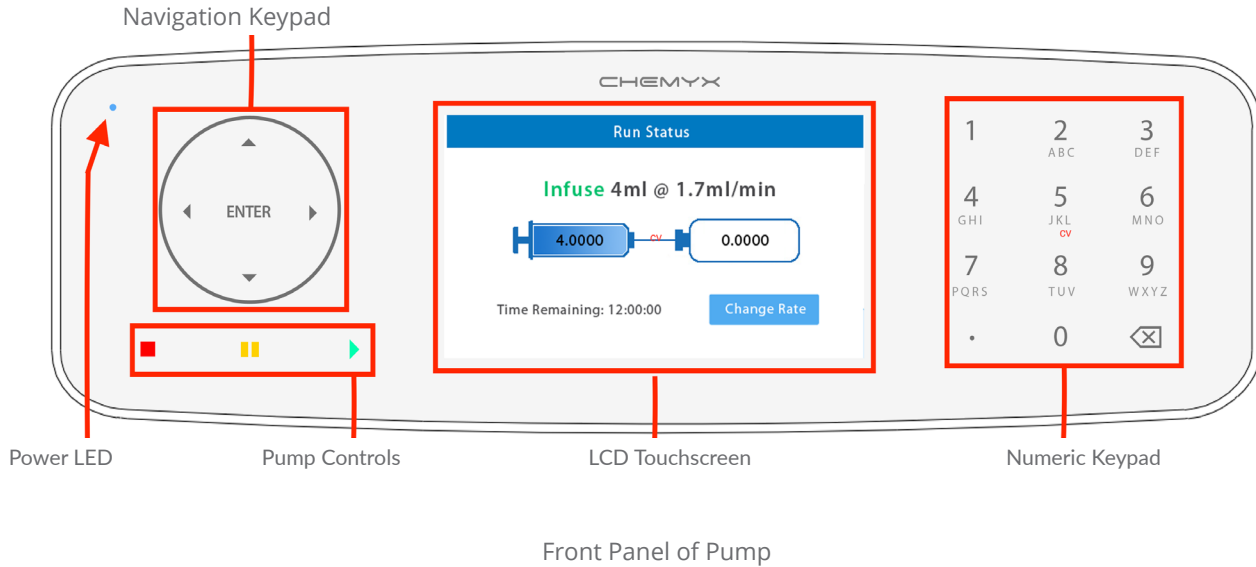

The Fusion Series uses a bright, 4.25", capacitive LCD touchscreen with an intuitive graphical user interface (GUI) for setting up detailed pump run methods. Buttons and entry fields within the GUI are all selectable using the touchscreen. As a capacitive LCD touchscreen, the interface can be operated with any object, not just the touch of a fingertip. Selecting elements by touch only requires a small amount of pressure; however, please do not use sharp objects as they may damage the screen.

The Fusion Series also includes physical navigation controls, allowing users to manually maneuver between selectable GUI elements without touching the screen. Inputting numbers and letters within the GUI is done using the physical numeric keypad. The physical pump control keys are used to start, pause, and stop pump activity.

The power LED and pump-control LEDs allow users to easily discern whether the pump is on and whether it is currently running, paused, or stopped.

## FUSION 4000-X SPECIFIC COMPO-

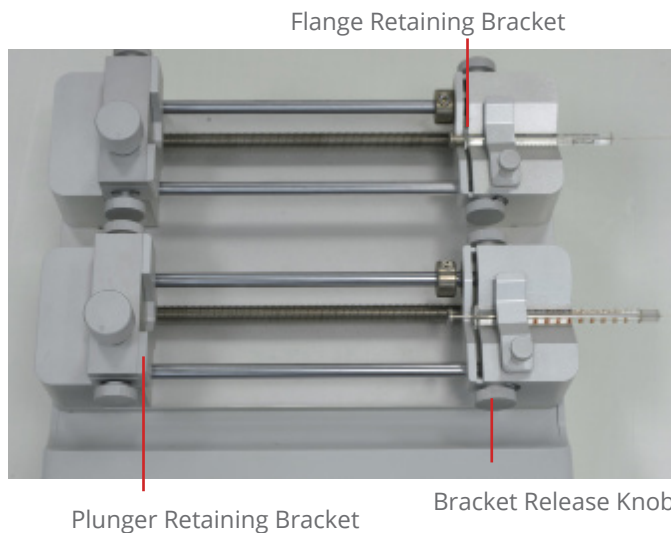

The Fusion 4000-X is capable of both infusion and withdrawal with two independently controlled pumps. The Fusion 4000-X uses adjustable retaining brackets on the pusher block and the syringe holder block, that keep each individual syringe channel in place during infusion and withdrawal.

# Fusion 4000-X Data Sheet

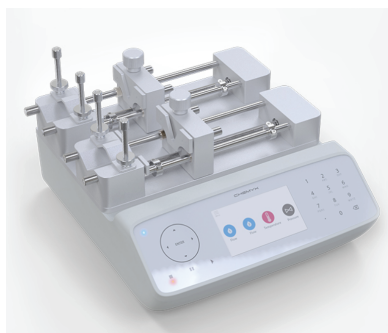

The Fusion 4000-X is a two independently controlled precision syringe pump that allows two syringes to be set up to run simultaneously or independently.

## TECHNICAL SPECIFICATIONS

<b>Mode</b>	Infuse/Withdraw
<b>Accuracy</b>	$\pm < 0.35\%$
<b>Reproducibility</b>	$\pm < 0.05\%$
<b>Syringe Size (Min/Max)</b>	0.5 $\mu$ L to 100mL
<b>Syringe Type</b>	Plastic, Glass and Stainless Steel
<b>Syringe Flow Rates</b>	See Syringe Library for Min & Max Flow Rates on Website
<b>Minimum Flow Rate</b>	.0001 $\mu$ L/min (with 0.5 $\mu$ L syringe)
<b>Maximum Flow Rate</b>	170.5 mL/min (with 100mL syringe)
<b>Linear Force</b>	85 lbs (38.5kg)
<b>Maximum Pressure</b>	See Max Pressure on Website
<b>Display</b>	4.3 inch LCD Glass Touch Screen
<b>Connectivity</b>	USB-B, RS232, RS485 and TTL Ports
<b>System Dimensions</b>	11 x 12 x 4.9 inches (28 x 31 x 13 cm)
<b>Power</b>	110/220 VAC
<b>Weight</b>	19 lbs (8.6kg)
<b>Motor Drive</b>	1.8° Stepper Motor with Micro-stepping
<b>Step Resolution</b>	0.0293 $\mu$ m/step
<b>Operating Temperature</b>	4°C to 40°C (40°F to 104°F)
<b>Storage Temperature</b>	-10°C to 70°C (14°F to 158°F)
<b>Humidity</b>	20% to 80% RH, non-condensing
<b>Installation Category</b>	II
<b>Regulatory Compliance</b>	CE, RoHS, REACH, FCC



# Pump Setup

## Powering On/Off the Pump

To provide power to the pump, a power cable should be plugged into the power socket on the back of the pump. The cable should be plugged into an appropriate power source (110V or 220V) with proper grounding.

The power switch for the pump is located on the back, above the power socket. Upon flipping the switch to the “on” position, the blue LED power light on the front of the pump will immediately turn on, along with the red LED light on the Stop key. In a few seconds, a beep will sound, and the LCD screen will display an initial startup screen.

The startup screen displays the version of the firmware currently installed on the pump at the top of the screen. The startup screen will display for approximately five seconds as indicated by the countdown on the right of the startup screen.

After the startup screen, the LCD screen will display the last mode the pump was in.

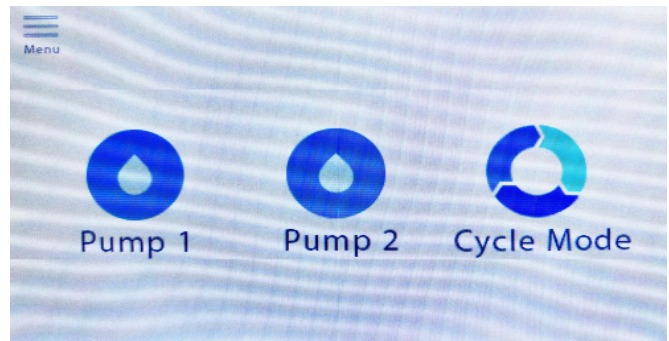

## Loading a Syringe

The Fusion 4000-X series can accommodate up to two syringes. The volume of the Fusion 4000-X syringes can vary from a minimum of 0.5  $\mu\text{L}$  up to a maximum of 100 mL. Syringes of any material (e.g., glass, plastic, stainless steel, etc.) can be used; however, some use cases may require syringes that are more accurate and durable.

### FUSION

1. If necessary, move and tighten the infusion safety collar (see Adjusting the Safety Collar).
2. While unscrewing the knob on the pusher block, the block will release to slide the pusher block all the way to the right.
3. Loosen the screw knobs for the flange retaining bracket and adjust the bracket such that the flange of the syringe barrel will fit in between. Do not tighten the bracket, yet.
4. Pull up on the spring-loaded syringe clamp and place the syringe in one of the channels of the holder block. Ensure that the flange of the syringe barrel is flush against the edge of the holder block. Slowly lower the syringe clamp to secure the syringe in place.

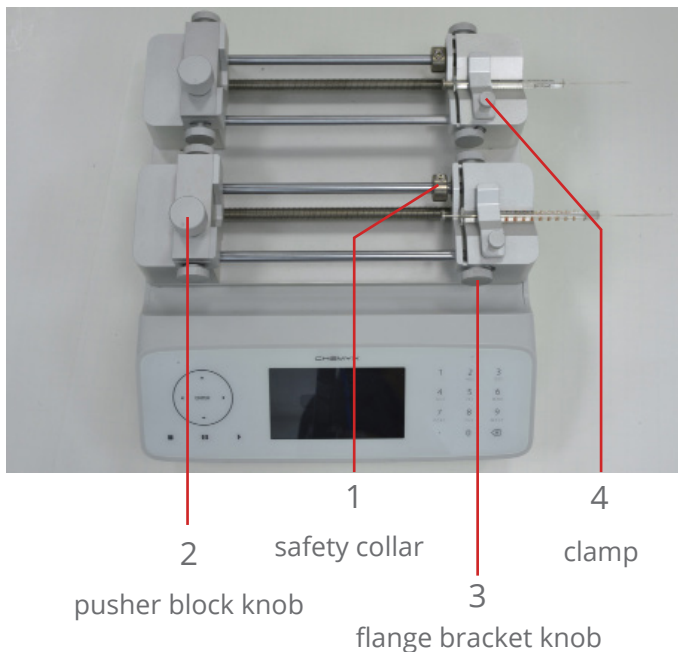

5. Loosen the bracket clamp knob for the plunger retaining bracket and adjust the gap such that the plunger cap of the syringe may fit.
6. Unscrew the knob to release the block and slide the pusher block to the right until it is flush against the syringe plunger. The plunger cap for the syringe should fit in the gap between the bracket and the pusher block.
7. Tighten the bracket clamp knob for the plunger retaining bracket to secure the syringe plunger in place.
8. Move the flange retaining bracket flush against the flange of the syringe barrel and tighten the bracket clamp knobs to secure the syringe barrel flange in place.

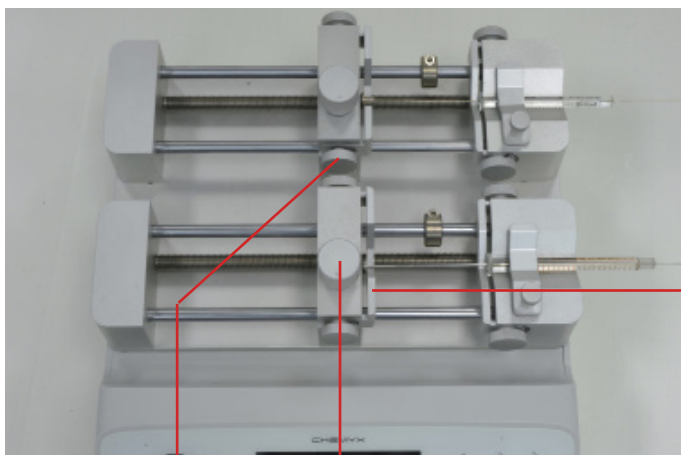

5  
plunger bracket knob

6  
pusher block knob

8 flange bracket knob

## Adjusting the Safety Nut/ Stall Rod

The Fusion Series pump can generate a significant amount of linear force. While this is extremely useful for dispensing viscous fluids at higher flow rates, the higher linear force of the Fusion series can also potentially damage the syringes in use. One source of potential damage of a syringe may occur when the plunger of the syringe is completely depressed, and the pusher block is still pushing against the syringe. Depending on the material of the syringe (i.e., glass or plastic) and the thickness of the plunger, the pressure from the pusher block could bend, distort, or just break the syringe.

To protect against this potential problem, Fusion 4000-X syringe pumps use safety collars. When a pusher block hits the safety mechanism and can no longer move forward, the pump will stop running, emit a long beep, and enter pump-stalled mode.

### FUSION 4000-X

Adjusting the safety collar requires the use of the hex key, conveniently stored on the back left of the pump, right above the power switch. Loosening the hex screw on the safety collar allows for the collar to be slid freely along the guide rod and then securely tightened to set the position of the safety collar. The position of the safety collar should be set slightly further from the syringe-block holder than the top of syringe plunger when fully depressed.

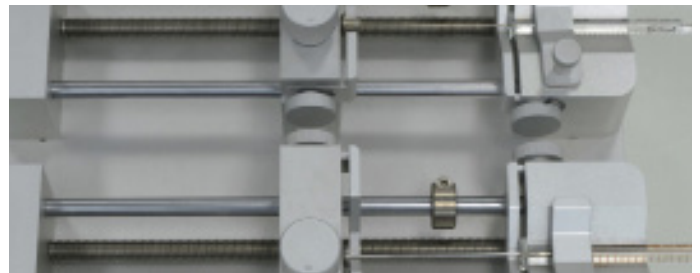

Safety collar adjustment

#### Caution:

On the Fusion Series, during withdrawal, a syringe plunger can potentially be pulled out from the syringe, which could cause the contents of the syringe to leak out. Users should be especially aware of the length of the plunger and the point where the withdrawing pusher block will exceed that length. There are no safety collars on the Fusion Series to prevent too much withdrawal.

# Pump Operation

## Operating Interface

Limits for selected fields	Max ID: 60.0000	Min ID: 0.00005	×
Selected Fields	Syringe:	4.73 mm	Find Syringe
	Volume:	1.00 ml	
Deselected Field	Pump Rate:	1.00 ml/min	

The LCD screen displays a graphical user interface (GUI) from which all the pump settings and run parameters are entered. Whenever an item is currently selected, the color scheme of the element typically turns to a darker shade of the color. For example, the light blue buttons turn dark blue when selected, and the white background surrounding a deselected editable text field turns blue when the field is selected and available for editing. Also, when a GUI element is selected, the top blue bar will show the activity performed (buttons only) or show the limits to the values that may be entered for the selected field (editable fields only).

Selecting the items that will be modified can be done two ways: (1) using the LCD touch screen or (2) using the navigation keypad.

All of the elements of the GUI can be interacted with by touch. Typical touch interactions are tapping a finger on a button or text field or sliding a finger to scroll. As a capacitive touch screen, these interactions are not restricted to only ungloved fingertips. Many types of objects can be used to select items on the screen with only very slight pressure, but avoid using sharp objects, as they may permanently damage the screen.

Elements of the GUI may also be selected using the navigation keypad on the front of the instrument to move between the elements.

**Tip** - Users may find the navigation keypad easier to use for scrolling through items in a scrollable list, such as the list of syringes in the syringe library.

To activate (or “press”) a button using the navigation keypad, select the button element such that it is highlighted and then press the **ENTER** key at the center of navigation keypad. Editable fields can immediately be edited upon selection without the need to press the **ENTER** key.

## NAVIGATING BETWEEN SCREENS

All of the screens in the Fusion Series GUI exist in a hierarchy, with the Mode Selection screen at the top. Entering a new screen is performed simply by activating, or tapping, a button or icon that opens the new screen.

To return to the previous screen, tap or activate the red “X” button in the top right of the screen. This will “close” the current screen, and return to the screen that was used to enter the closed screen. This can also be accomplished by pressing the Stop key on the front of the instrument when the pump is not running.



## ENTERING NUMBERS

Most editable fields will require the user to enter numbers, which is done using the numeric keypad on the front of the instrument.

Upon first selecting an editable field, pressing any number will first clear the old value and replace it with the new value. This only applies when first selecting the field. On a field that has already been selected and edited, any further edits will just append the number to the end. In such a case, to clear the current value in the field, press the white **C** key on the numeric keypad.

Values entered in an editable field are accepted upon pressing the **ENTER** key, selecting a new element, or pressing the **Start** key. Values that exceed the limits of the editable field (shown in the blue bar at the top of the screen) are automatically corrected to be within the limits upon accepting the value.

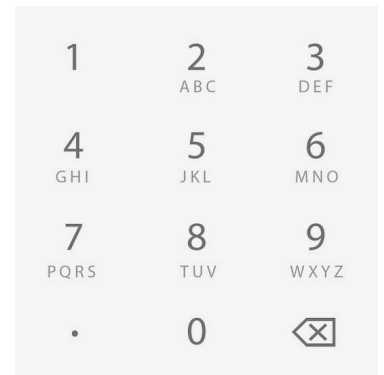

Physical Numeric Keypad

## MODE SELECTION SCREEN



Fusion 4000-X Mode

The **Mode Selection** screen is the top level menu for the Fusion series pumps. The Fusion 4000-X screen allows users to select between pumps and Cycle Mode.

## Basic Mode

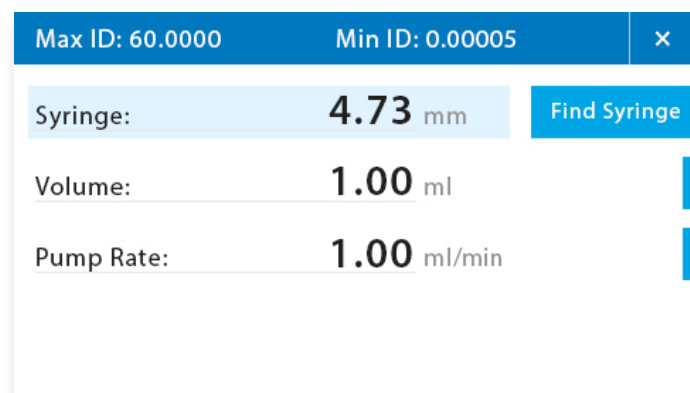

The screenshot shows the 'Basic Mode Screen' with a blue header bar containing 'Max ID: 60.0000' and 'Min ID: 0.00005' with a close button (X). Below the header, there are three input fields: 'Syringe:' with a value of '4.73 mm' and a 'Find Syringe' button; 'Volume:' with a value of '1.00 ml'; and 'Pump Rate:' with a value of '1.00 ml/min'.

Basic Mode Screen

**Basic Mode** (or Single-Step Mode) is used for applications that do not require advanced automation, variable volume and rate settings, step looping, or ramping rates.

The **Basic Mode** screen can be reached by tapping on the water droplet icon on the **Mode Selection** screen.

**Basic Mode** allows users to select the syringe being used, to set a valid volume and rate, and to choose whether to infuse or withdraw.

The pump can only be started in **Basic Mode** while the **Basic Mode** screen is displayed.

## SYRINGE SELECTION

For every application, the first required step for setup is to select the inner diameter (ID) of the syringe(s) being used. This value is important for the syringe pump to accurately calculate the transfer rate and the total transferred volume for the liquid in the syringe. There are two approaches to entering this value: (1) enter a custom inner diameter or (2) use the built-in syringe library to import an inner diameter.

Entering a custom inner diameter (ID) is as simple as typing in the ID in millimeters in the **Syringe** editable field. The maximum and minimum values for the ID are displayed in the blue bar at the top of the screen while the **Syringe** editable field is selected. This value is also limited to only three decimal places, where any additional decimals or trailing zeroes are dropped. If the value of the Volume field is smaller/larger than the min/max volume allowed for the input inner diameter, the value in the Volume field will be adjusted to be within range. Otherwise, no changes to the volume will occur.

Tapping the **Find Syringe** button to the right of the **Syringe** editable field will open a new **Syringe Library** screen. Syringe manufacturers are found in the list on the left. Selecting a manufacturer will display all of the syringes available from that manufacturer in the list on the right. The list of syringes typically indicates the volume of the syringe first, followed by the inner diameter of the syringe. Both lists can be scrolled through by dragging a finger on the scroll bar; however, the easiest approach in this screen may be to use the navigation keypad to scroll through the lists. A list of the syringes in the library can be found in Appendix A.

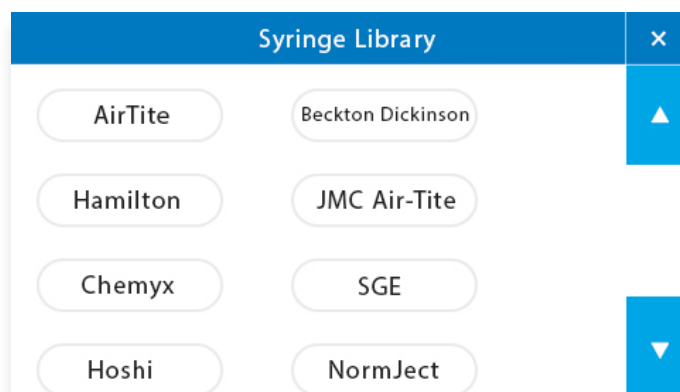

The screenshot shows the 'Syringe Library' screen with a blue header bar containing 'Syringe Library' and a close button (X). The screen is divided into two columns of manufacturer buttons: 'AirTite', 'Hamilton', 'Chemyx', and 'Hoshi' on the left; 'Beckton Dickinson', 'JMC Air-Tite', 'SGE', and 'NormJect' on the right. A vertical scroll bar is on the right side of the buttons, with an upward arrow at the top and a downward arrow at the bottom.

Syringe Library Screen

When a particular syringe is selected from the list on the right, an **Import** button will appear next to the selected item. Tapping the **Import** button (or pressing the Enter key on the navigation keypad) will import the inner diameter associated with the selected syringe and exit the **Syringe Library** screen.

Upon import of a syringe from the syringe library, the **Syringe** editable field will be updated to the new inner diameter, and the Volume editable field will be updated to the volume of the imported syringe. Please note that the volume units and values for the **Volume** and **Rate** fields may change to match the units of volume displayed for the syringe in the **Syringe Library**.

## VOLUME

The **Volume** field represents the total volume of liquid that the pump will transfer (infusion or withdrawal) before stopping. The amount of time that the pump will run with the set target volume can be determined by dividing the volume by the flow rate.

The value entered can be any integer or decimal within the limits for the syringe. The min/max volume limits can be found in the blue bar at the top of the screen when the Volume field is selected. Any entered value beyond these limits will be automatically adjusted to the minimum or maximum limit, whichever is closer. The total number of decimal places is limited to five.

The volume can be stated in units of mL or  $\mu\text{L}$ . The units used for the volume are dependent upon the set units of volume for the flow rate in the **Options** screen.

To continuously run the pump and use the entire volume of the syringe, users can set the volume to the total volume of the syringe or to the maximum limit. However, users are strongly encouraged to set the safety collar/bar (see Adjusting the Safety Collar) so that the pump does not potentially ruin the syringe.

### **Important Note:**

The maximum volume limit for a syringe assumes that the length of the syringe is the length of the pump. Therefore, this maximum volume limit is almost always larger than the actual volume the syringe can hold.



## Infusion/Withdrawal

The Fusion Series is capable of both infusion and withdrawal. On the systems, an **Infusion/Withdrawal** toggle button should appear to the right of the Volume field. The text and arrow direction on the button indicates the mode that is currently set and direction that the pusher block will move upon starting the run. Tapping the button will switch between the two modes.

### FLOW RATE

The **Flow Rate** fields indicates how fast the pusher block will move. The amount of time that the pump will run can be determined by dividing the set volume by the flow rate.

For each field, the value entered can be any integer or decimal within the limits for the syringe. The min/max flow rate limits can be found in the blue bar at the top of the screen when the Rate field is selected. Any entered value beyond these limits will be automatically adjusted to the minimum or maximum limit, whichever is closer. The total number of decimal places is limited to five.

The rate can be stated with four different units: mL/min, mL/hr,  $\mu$ L/min, and  $\mu$ L/hr. Adjusting the units will affect the min/max limits for the Rate field. The units for rate can be set in Options during the multi-step setup.

The screenshot displays the pump's configuration screen. At the top, a blue bar shows 'Max Volume: 100' and 'Min Volume: 0.0191' with a close button (X). Below this, the 'Syringe' field is set to '34.9 mm'. The 'Volume' field is set to '100 ml'. The 'Pump Rate' field is set to '1.00 ml/min'. On the right side, there are two buttons: 'Accept' (light blue) and 'Cancel' (dark blue). At the bottom, there are two radio button options: 'Infuse' (selected) and 'Withdraw', and two radio button options for 'Set Units: ml' (selected) and 'Set Units: ul'.

## START-TIME DELAY

The Delay field represents the amount of time (in minutes and seconds) to delay starting the pump after the current step begins.

When entering this value with the numeric keypad, the decimal key is used to indicate the separation between minutes and seconds. The first two values entered will be in minutes unless a zero is the first value or a decimal is entered, the occurrence of which causes the next values to be in seconds.

### Example:

To set a delay of 1 min and 30 seconds, press the “1” key, then the decimal key, and finally the “3” and “0” keys. To set a delay of 45 seconds, press the decimal key, then the “4” and “5” keys.

To remove the delay, simply press the clear key (C) or set the time to zero.

## STEP LOOP

The **Step Loop** field determines how many additional times to sequentially perform the particular step. This is the lowest-level loop that iterates whenever that particular step is reached and completed.

### Example:

In a multi-step method of five steps (1, 2, 3, 4, 5) where Step 4 has a Step Loop of “2”. The method will run the following steps sequentially: 1, 2, 3, 4, 4, 5. When the step loop is set to “2”, Step 4 is repeated twice more. If the entire method also has a Loop All setting of “1”, the method would run the following steps sequentially: 1, 2, 3, 4, 4, 4, 5, 1, 2, 3, 4, 4, 4, 5.

The **Step Loop** field takes any integer from 0 to 99. A value of 0 indicates that the method will run the step only once. Any value above zero represents additional times to run the step.

In the **Pump Running** screen, the number of remaining loops of the current step appears on the right, next to the repeat icon.

The screenshot shows a control interface for a pump. At the top, there are two fields: "Max Rate: 170.4702" and "Min Rate: 0.0002", with a close icon (X) to the right. Below these are two rows: "Syringe: 34.9 mm" and "Volume: 100 ml". The next row is "Pump Rate: 1 ml/min", with a blue "Accept" button to its right. Below that is a "Delay @ Start" section with two radio buttons: "Time Units: min" (selected) and "Time Units: hr". To the left of the radio buttons is a time display showing "00 : 00 mm:ss". A blue "Cancel" button is located to the right of the radio buttons.

## Options

The Fusion Series is capable of both infusion and withdrawal. On the systems, an Infusion/Withdrawal toggle button should appear when the Volume field is selected. The bubble form indicates the mode that is currently set and direction that the pusher block will move upon starting the run.

The image shows a 'Volume Settings' dialog box. At the top, it displays 'Max Volume: 60.0000' and 'Min Volume: 0.00005' with a close button (X). Below this, there are several fields: 'Syringe: 4.73 mm', 'Volume: 1.00 ml', and 'Pump Rate: 1.00 ml/min'. To the right of the 'Volume' field are two buttons: 'Accept' and 'Cancel'. Below the 'Volume' field, there are two rows of radio buttons. The first row has 'Infuse' (selected) and 'Set Units: ml'. The second row has 'Withdrawal' and 'Set Units: ul'.

Volume Settings screen

### FLOW-RATE UNITS

The flow-rate units determine which units of volume and time will be used for the **Volume** and **Rate** fields. This setting in **Basic Mode** also changes the units for **Multi-Step Mode**.

**Note:**

Even if the units have changed, the values within the **Volume** and **Rate** fields will not change, which will result in significant changes in the flow rate and volume transferred. Additionally, the min/max limits for these fields will also be changed, so if the current values for volume and rate exceed the new limits, they will be adjusted to be within those set limits.

# How To Use Cycle Mode

## FOLLOW THESE STEPS

1. Using the same syringe sizes, load your syringes.

2. Select "Cycle Mode":

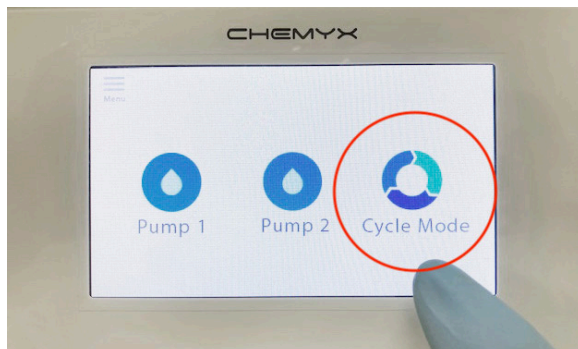

5. Press "Start Cycle Mode":

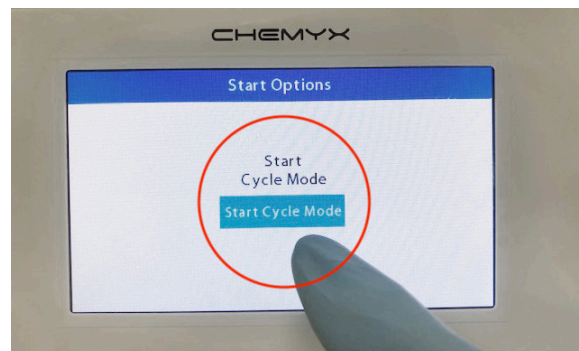

3. Set your parameters. The system will automatically set the same parameters (ID, Volume, and Rate) for both syringes

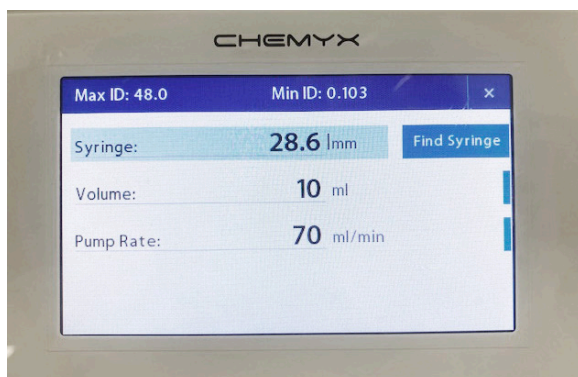

6. Press "Stop" to Stop:

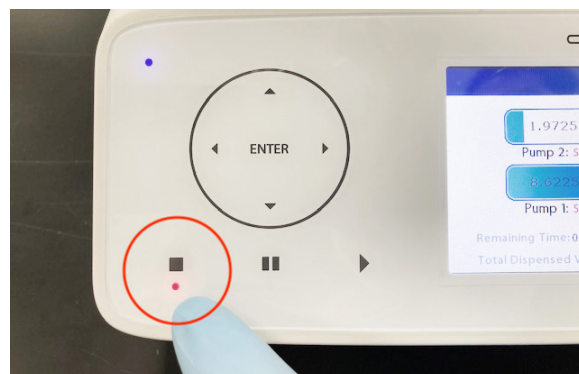

4. Press "Play":

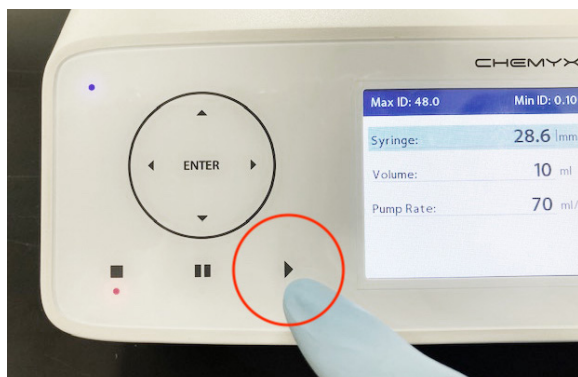

# Multi-Step Mode

**Multi-Step Mode** is used for more advanced applications that may require numerous steps, multiple different volume and rate settings, step looping, or ramping rates.

The **Multi-Step Mode** screen can be reached by tapping on the Menu icon on the **Mode Selection** screen.

The pump can only be started in **Multi-Step Mode** when the **Multi-Step Mode** screen is showing. This also holds true for computer control of the pump through a serial connection; the pump must be switched to the **Multi-Step Mode** screen on the pump interface first.

## SETUP

Max ID: 60.0000	Min ID: 0.00005	×
Syringe: 4.73 mm	Steps: 4	▲
Step1 (ml, ml/min): 1.00 1.00	▶	
Step2 (ml, ml/min): 1.00 1.00	▶	
Step3 (ml, ml/min): 1.00 1.00	▶	▼

Multi-Step Mode Setup screen

In **Multi-Step Mode**, the left side of the screen shows a list of selectable items. The first (topmost) item in this list is **Setup**. Tapping **Setup** will take users to the **Multi-Step Method Setup** screen, where the syringe inner diameter (ID), total number of steps, number of loops, and flow-rate units can be set.

## SYRINGE SELECTION

Syringe selection for **Multi-Step Mode** works in much the same manner as seen in **Basic Mode**.

Changes in the syringe ID will affect the min/max values for the Volume field in all steps. However, unlike **Basic Mode**, importing a syringe from the Syringe Library will not change the volumes in each step to the volume of the syringe unless they exceed the volume limits of the new syringe. All values in each step that are outside these new limits will be adjusted to be within the limits.

### Tip:

Because changing the values of the syringe ID may possibly change the values and units for volume and rate, selecting a syringe or entering the syringe ID should always be the first step when setting up a run.

## TOTAL STEPS

The **Total Steps** field determines how many steps will occur in the method. Each step has independent values for **Volume**, **Rate**, **Delay**, and **Infusion/Withdrawal**. Upon entering the number of steps, the list on the left of the screen will update to show all of the steps. Each one of the steps will have their own set of parameters that will need to be set (see Step Parameters).

A minimum of 1 and maximum of 20 steps can be entered as a method.

Adding steps is accomplished by increasing the **Total Steps**, which will add the new steps at the end of the list. Decreasing the **Total Steps** will remove steps from the end of the list. In either case, the values in the Step Parameters for each existing step does not change upon the addition or deletion of steps.

In the case that the number of steps in the list on the left side of the screen exceeds the available space on the screen, a blue triangle arrow will appear below the list indicating that it can scroll. This list can scroll two ways: (1) the user can drag their finger up and down on the list to scroll the list and then tap on the item of interest; or (2) the user can use the up/down arrows in the navigation keypad to scroll through the items.

The **Loop All** field determines how many additional times the pump will perform all of the steps. This is the highest level loop and is the last loop to iterate after all the steps and step loops have completed.

### Example:

In a multi-step method of three steps (1, 2, 3) where the Loop All is set to "2". The method will run the following steps sequentially: 1, 2, 3, 1, 2, 3, 1, 2, 3. As shown, the method will loop through all three of the steps two additional times.

The **Loop All** field takes any integer from 0 to 99. A value of 0 indicates that the method will run through the entirety of steps only once. Any value above 0 represents additional times to run all of the steps.

In the pump running screen, the current loop number and total number of loops are indicated in the blue bar at the top of the screen.

## FLOW-RATE UNITS

Tapping the **Volume** or **Pump Rate** button opens a screen that allows flow-rate units to be set. The flow-rate unit determines which unit of volume and time will be used for the **Volume** and **Rate** fields for all of the steps. This setting in Multi-Step Mode also changes the units for Basic Mode.

The image displays two screenshots of the 'Multi-Step Mode Options' screen. Both screens have a blue header with 'Max Volume: 60.0000' and 'Min Volume: 0.00005' (left) or 'Max Rate: 60.0000' and 'Min Rate: 0.00005' (right), and a close button 'x'.

**Left Screenshot (Volume selected):**

- Syringe: 4.73 mm
- Volume: 1.00 ml
- Buttons:  Infuse,  Set Units: ml,  Withdraw,  Set Units: ul
- Pump Rate: 1.00 ml/min
- Buttons: Accept, Cancel

**Right Screenshot (Pump Rate selected):**

- Syringe: 4.73 mm
- Volume: 1.00 ml
- Pump Rate: 1.00 ml/min
- Buttons:  Time Units: min,  Time Units: hr
- Delay @ Start: 00:00 hh:mm
- Buttons: Accept, Cancel

Multi-Step Mode Options screen

### Important Note:

Even if the units have changed, the values within the Volume and Rate fields will not change, which will result in significant changes in the flow rate and volume transferred. Additionally, the min/max limits for these fields will also change, so if the current values for volume and rate exceed the new limits, they will be adjusted to be within the limits.

## Step Parameters

Max ID: 60.0000		Min ID: 0.00005		×
Syringe:	4.73 mm	Steps:	4	▲
Step1 (ml, ml/min):	1.00	1.00	▶	
Step2 (ml, ml/min):	1.00	1.00	▶	
Step3 (ml, ml/min):	1.00	1.00	▶	▼

Multi Step Program Screen

Every step in the multi-step method will have a selectable entry in the list. At the top of the screen you will find a place to enter your syringe size as well as the number of steps the multi-step method to take. Tapping the step will allow you to change the Volume and Rate. The arrows on this screen represent infuse or withdraw for each step.

### VOLUME

The **Volume** field represents the total volume of liquid that the pump will attempt to transfer (infusion or withdrawal) before completing the step. The amount of time that the pump will attempt to run with the set volume can be determined by dividing the volume by the flow rate (as long as the flow rate is static).

The value entered can be any integer or decimal within the limits for the syringe. The min/max volume limits can be found in the blue bar at the top of the screen when the Volume field is selected. Any entered value beyond these limits will be automatically adjusted to the minimum or maximum limit, whichever is closer. The total number of decimal places is limited to five.

The volume can be stated in units of mL or  $\mu$ L. The units used for the volume are dependent upon the set units of volume for the flow rate in the **Options** screen during the multi-step setup.

To continuously run the pump and use the entire volume of the syringe, users can set the volume to the total volume of the syringe or to the maximum limit. However, users are strongly encouraged to set the safety collar/bar (see Adjusting the Safety Collar) so that the pump does not potentially ruin the syringe.

#### Important Note:

Even if the units have changed, the values within the Volume and Rate fields will not change, which will result in significant changes in the flow rate and volume transferred. Additionally, the min/max limits for these fields will also change, so if the current values for volume and rate exceed the new limits, they will be adjusted to be within the limits.



## PUMP CONTROL

The pump's actions are controlled by the **Stop**, **Pause**, and **Start** keys on the front. In order to start a run, the screen should be showing either the **Basic Mode** (for basic runs) or **Multi-Step Mode** (for multi-step runs) main screens. Pressing the Start key in either other these screens will start a run with the currently set parameters.

Amount	Functions
Start	<p>Pressing the <b>Start</b> button once will start a new run with the currently displayed parameters or resume a paused run. This button is only functional when a run is currently paused or when the display is showing the <b>Basic Mode</b> or <b>Multi-Step Mode</b> screens that show the current parameters.</p> <p>Pressing the <b>Start</b> button while a delay countdown is occurring will immediately skip the remaining delay time and start the run/step.</p> <p>Pressing and holding the Start button will begin priming, where the pump will continuously run at the Prime/Bolus Rate as long as the button is being pressed. The Prime/Bolus Rate is set in Basic Mode &gt; Options. Priming is only available in Basic Mode.</p> <p>The green LED light on the Start button will be on while the pump is running.</p>
Pause	<p>While the pump is running, pressing the <b>Pause</b> button will pause the current run. Pausing allows the pump to continue the same run from the point when the pause occurred.</p> <p>The yellow LED light on the Pause button will be on when the current run has been paused.</p>
Stop	<p>During a run, pressing the <b>Stop</b> button will immediately stop the run, and return the display to the <b>Basic Mode</b> or <b>Multi-Step Mode</b> screen.</p> <p>While outside of an active run, pressing the Stop button will exit the current screen. This result is the same as activating the "X" button in the top right corner of the screen by touch or navigational keypad.</p> <p>The red LED light on the <b>Stop</b> button will be on whenever the pump is neither actively running nor paused. The light will also be on for active runs that are currently in a delay before starting a step.</p> <p>The red LED light will blink if the pump has stalled.</p>

Upon starting a pump run, the screen will switch to the **System Status** screen. There are two different versions of this screen depending upon whether the pump was started in **Basic Mode** or **Multi-Step Mode**.

## RUN STATUS

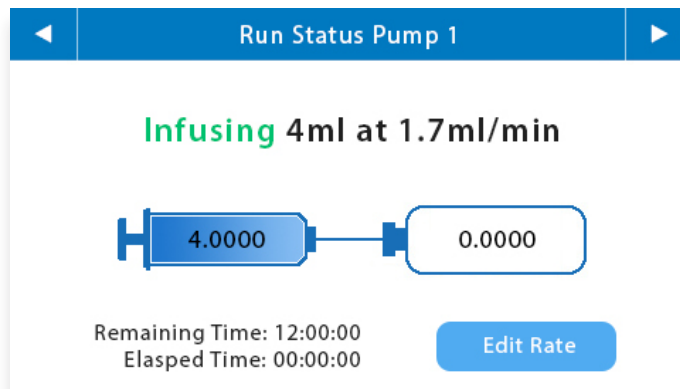

Basic Mode System Status screen

The **Run Status** screen for **Basic Mode** highlights the current activity of the pump during a run.

The **Elapsed Time** field indicates how much time has passed since the pump has started physically running, not including any start-time delay. The **Infusion Time** field shows the calculated total time for the current run to finish, barring any pause or stall in the instrument.

The two rectangular blocks on the screen illustrate the transfer of volume during the run. The left rectangle represents the volume in the syringe while the right rectangle represents the volume transferred in or out of the syringe. While the pump is running, a small arrow will appear between the two rectangles indicating the direction of flow. Depending upon the direction of the arrow, the numbers within each rectangle will change as volume is transferred.

The colored text directly next to the volume rate amount indicates the current status of the pump: green - running; yellow - paused or delayed; and red - stopped or stalled.

The **Volume**, and **Rate** fields indicate the parameters that were set for the currently running method in the **Basic Mode** main screen.

Tapping the **Edit Rate** button allows users to change the flow rate of the pump in the middle of the run.

## START OPTIONS

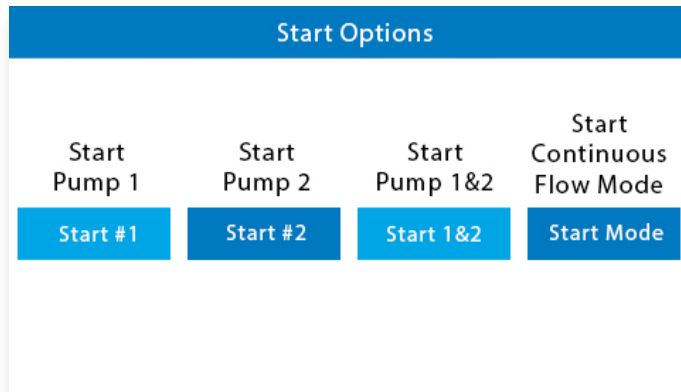

Start Options

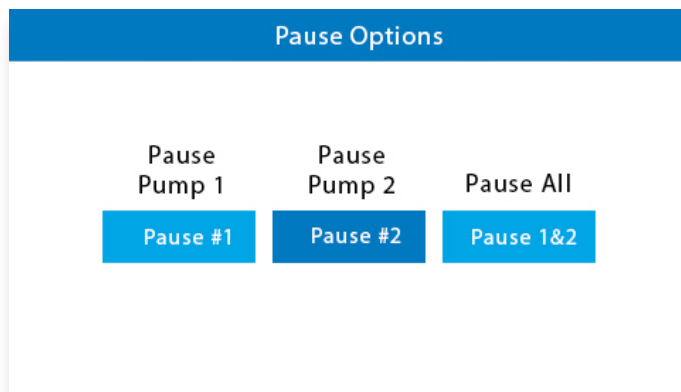

Pause Options

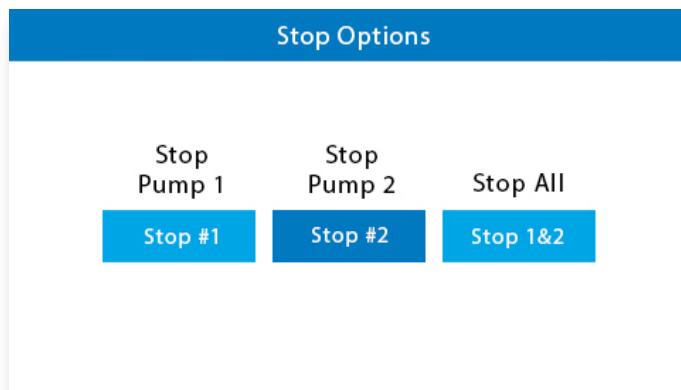

Pause Options

When starting the Fusion 4000-X pump a display of start options will be shown. User will be required to select one option based on the pump that needs to be started. Other functions are also available to pause and stop the pump once the pump has started.

# System Settings

The **System Settings** screen can be reached by tapping on the Menu icon on the **Mode Selection** screen.

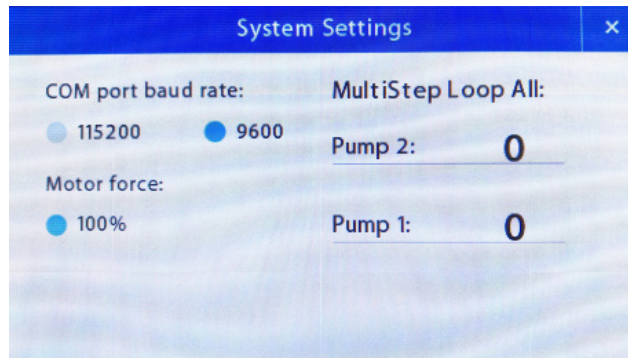

System Settings screen

## BAUD RATE

The baud rate is the rate at which information is transferred through the serial connection. This rate is often limited by the type of serial connection used.

The Fusion Series pumps provide two possible baud rates: 9600 and 115200.

Serial connections using the USB-B port on the back of the pump should use the faster baud rate of 115200.

Serial connections using the DB9 port on the back of the pump will need to use the slower baud rate of 9600.

See Pump Control by Computer for more information.

The **System Settings** screen can be reached by tapping on the Power icon on the **Mode Selection** screen.

## MOTOR FORCE

The Fusion 4000-X pumps can generate up to a maximum of 80lbs of linear force.

## LCD POWER-OFF TIME

The LCD display goes to sleep after 1 hour after the last interaction with the pump controls. When the display goes to sleep, the pump is still on. It will continue to run the current method and is able to receive commands via computer connection.

# Pump Control by Computer

## Cable Requirements

Two types of connections are available for external computer control: DB9 and USB, cables for each are available for purchase through Chemyx (call 1-281-277-5499 or visit [www.chemyx.com/contact-us](http://www.chemyx.com/contact-us)).



DB9 Serial Cable (Male-to-Female)



USB-A to USB-B cable

For the DB9 serial connection, a Male-to-Female DB9 cable must be used. Do not use any “null modem,” “crossover,” or “crossed-over” cables. The cable can be of any length up to 50 ft; however, the speed of the connection is often detrimentally affected at lengths over 15 ft.

For a USB serial connection, a USB-A to USB-B cable should be used. The maximum possible length of a single USB cable is 15 ft; however, USB cables should be less than 10 ft for optimum performance. Multiple USB cables can be chained together to make a longer connection as long as the hub connecting each individual cable is connected to a power supply.

A USB-to-DB9 serial adapter can be used to connect a DB9 serial connection to the USB port on a computer.

All of these connections require the proper drivers to be installed on the computer. Typically, most current operating systems already contain drivers for the USB serial connection. They may also already have drivers for the DB9 serial connection. USB-to-DB9 adapters typically need to have a USB-to-serial driver installed. For more information on downloading and installing drivers please visit [www.chemyx.com/support](http://www.chemyx.com/support).

## Connecting

Most computer operating systems (e.g., Windows, macOS, Linux, etc.) have built-in terminal programs that can be used to type in the commands that run the pump. On Windows XP and earlier, HyperTerminal can be used to control the pump. On macOS and Linux, the screen command in Terminal can also be used to control the pump. There are also numerous third-party programs for serial connections that exist for each operating system that may be easier to use and provide more features. A third-party program will be necessary to connect with computers running Windows Vista and later.

For tips on operating the built-in terminal programs and information on available third-party programs, please visit [www.chemyx.com/support](http://www.chemyx.com/support).

## COM PORT SETTINGS

Regardless of the operating system being used, the terminal program controlling the serial connection should use the following connection settings:

Baud Rate	9600 or 115200
Data Bits	8
Parity	None
Stop Bits	1
Flow Control	None

The baud rate setting for the serial connection must match the baud rate set in the pump settings GUI (See Baud Rate in System Settings).

Generally, the pump should be set to use the higher baud rate (115200) if a USB-only connection is used. However, if a DB9-only or USB-to-DB9 connection is used, the baud rate must be set to 9600.

Typically, if the baud rate is not set correctly, there will be garbled or no response to any commands

## Pump Commands

Regardless of the operating system being used, the terminal program controlling the serial connection should use the following connection settings:

Command	Description
help	Displays a list of available commands.
start	Starts the pump with the currently set parameters. The parameters that will run depend upon which mode ( <b>Basic Mode</b> or <b>Multi-Step Mode</b> ) the pump touchscreen is showing.
pause	Pauses the current pump run. The run can be resumed from this point using the <i>start</i> command.
stop	Ends the current run. The run cannot be resumed and can only be restarted from the beginning.
set diameter X	<p>Sets the inner diameter (ID) of the syringe in millimeters.</p> <p>This setting simultaneously affects the syringe ID used in both <b>Basic Mode</b> and <b>Multi-Step Mode</b> settings, which will also affect the volume and rate parameters in both modes.</p> <p>X can be an integer or decimal (up to three decimal places) from 0.103 mm to 40.000 mm.</p> <p><b>Example</b> <code>set diameter 11.73</code></p> <p>Returns the diameter.</p>
set units X	<p>Sets the units used for the rate of infusion/withdrawal. This parameter also sets the units for transfer volume, where the transfer volume unit will be the same as the volume unit used in the rate.</p> <p>This setting simultaneously changes the units used in both <b>Basic Mode</b> and <b>Multi-Step Mode</b> settings.</p> <p>X can be an integer from 0 to 3. Each integer represents a specific rate unit.</p> <p>0 = mL/min 1 = mL/hr 2 = <math>\mu</math>L/min 3 = <math>\mu</math>L/hr</p> <p><b>Example</b> <code>set units 2</code></p> <p>Returns the integer corresponding to the set rate unit.</p>

Command	Description
<p>set volume X,X,X,...</p>	<p>Sets the transfer volume. The pump will run until the volume infused or withdrawn equals this volume. This command also sets whether the pump is infusing or withdrawing (Fusion 200 only) and the number of steps used in Multi-Step Mode.</p> <p>X must be an integer or decimal (up to five decimal places) within the volume limits for the syringe (See read limit parameter command). A negative sign can be added in front of any value to indicate a switch to withdrawal mode (Fusion 200 only).</p> <p>For Basic Mode, only one value is required. Entering only one value will automatically switch the pump to Basic Mode.</p> <p><b>Example</b> set volume 25.0</p> <p>To set volumes in Multi-Step Mode, the pump must be manually switched to Multi-Step Mode on the pump. For each step, a value must be entered, separated by commas and no spaces. The number of steps will be automatically adjusted to the number of values entered (i.e., entering only three values will change the number of steps to three).</p> <p><b>Example</b> set volume 3,-2,4</p> <p>Returns the transfer volume, transfer rate, and transfer time (in Basic Mode).</p> <p>Returns only the transfer volumes (in Multi-Step Mode).</p>
<p>set time X,X,X,...</p>	<p>Sets the target time for a pump run. This will adjust the transfer rate so that the run will last for the input time. The target volume will remain the same. This command also sets the number of steps used in Multi-Step Mode.</p> <p>X must be an integer or decimal (up to five decimal places). The resulting transfer rate must be within the rate limits for the syringe (See read limit parameter command).</p> <p>For Basic Mode, only one value[ is required. Entering only one value will automatically switch the pump to Basic Mode.</p> <p><b>Example</b> set time 1.0</p> <p>To set target times in Multi-Step Mode, the pump must be manually switched to Multi-Step Mode on the pump. For each step, a value must be entered, separated by commas and no spaces. The number of steps will be automatically adjusted to the number of values entered (i.e., entering only three values will change the number of steps to three).</p> <p><b>Example</b> set time 1.0,0.5,1.3</p> <p>Returns target time and rate (in Basic Mode).</p> <p>Returns no values (in Multi-Step Mode).</p>



Command	Description
<p>set rate X,X,X,...</p>	<p>Sets the transfer rate for infusion/withdrawal.</p> <p>X must be an integer or decimal (up to five decimal places) within the rate limits for the syringe (See read limit parameter command).</p> <p>For Basic Mode, only one value is required.</p> <p><b>Example</b>  <pre>set rate 1.0</pre></p> <p>To set rates in Multi-Step Mode, the pump must be manually switched to Multi-Step Mode on the pump. For each step, a value must be entered, separated by commas and no spaces.</p> <p><b>Example</b>  <pre>set rate 1.0,0.5,1.3</pre></p> <p>If the number of values is less than the number of steps, the remaining steps will gain the same rate value as the last entered value. Any extra values beyond the number of steps will be truncated.</p> <p><b>Example</b>  <pre>set rate 0.5/1.0,0.5/1.0,1.3</pre></p> <p>Returns the flow rate and transfer time (in Basic Mode).</p> <p>Returns the flow rate 1 and flow rate 2 for each step (in Multi-Step Mode).</p>

Command	Description
set delay X,X,X,...	<p>Sets the start time delay (in minutes) prior to each step of a pump run. Upon starting the a step, the pump will wait until the delay time elapses before starting to transfer volume.</p> <p>X must be an integer or decimal (up to five decimal places) within the rate limits for the syringe (See read limit parameter command).</p> <p>For Basic Mode, only one value is required. Entering only one value will automatically switch the pump to Basic Mode.</p> <p><b>Example</b>  <pre>set delay 1.0</pre></p> <p>To set rates in Multi-Step Mode, the pump must be manually switched to Multi-Step Mode on the pump. For each step of Multi-Step Mode, a value must be entered, separated by commas and no spaces.</p> <p><b>Example</b>  <pre>set delay 1.0,0.5,1.3</pre></p> <p>If the number of values is less than the number of steps, the remaining steps will gain the same delay value as the last entered value. Any extra values beyond the number of steps will be truncated.</p> <p>Returns the delay time (in Basic Mode).</p> <p>Returns the delay time for each step (in Multi-Step Mode).</p>
read limit parameter	<p>Returns the min/max values that can be set for transfer volume and transfer rate. The returned values are dependent on the syringe inner diameter (ID). The transfer volume limits are typically greater than the maximum volume of the syringe being used.</p> <p>Returns: max rate, min rate, max volume, min volume</p>
dispensed volume	<p>Returns the transferred volume for the current run/step. If no run has started, returns the transferred volume for the last run/step.</p>
elapsed time	<p>Returns the elapsed time (in minutes) for the current run/step. If no run has started, returns the elapsed time for the last run/step. Elapsed time does not include any delay time.</p>
view parameter	<p>Returns the currently set parameters (Basic Mode only).</p> <p>Returns: rate units, syringe inner diameter, transfer rate, priming rate, time (in whole number minutes), transfer volume, time delay (in whole number minutes)</p>

Command	Description
status	<p>Returns the current status of the pump. The returned integer correlates to the status of the pump.</p> <p>0: Pump stopped  1: Pump running  2: Pump paused  3: Pump delayed  4: Pump stalled</p> <p>Returns: integer that represents the current status of the pump.</p>
hexw2XXXXXX start	<p>Sets multiple parameters in one command (Basic Mode only).</p> <p>X variables in order:  units: see set units command  transfer mode: 0-infusion, 1-withdrawal  syringe ID: see set diameter command  transfer volume: see set volume command; no negatives  transfer rate: see set rate command  start time delay: see set delay command</p> <p><b>Example</b>  The following example shows the command using these parameters:  units = mL/min; transfer mode = withdrawal; diameter = 23.05 mm;  volume = 1.2 mL; rate = 3.0 mL/min; delay = 30 sec (0.5 min)  hexw2 0 1 23.04 1.2 3.0 0.5</p> <p>A start command can be added after the six parameters to immediately start the run with the new parameters.</p> <p><b>Example</b>  hexw2 0 1 23.04 1.2 3.0 0.5 start</p> <p>All six parameters do not need to be entered; however, all parameters up to the parameter(s) of interest must be also be included. The other parameters not entered will remain as they are currently set.</p> <p><b>Example</b>  hexw2 0 1 23.04 2.4</p>
save setting	Deprecated command.

Command	Description
set primerate X	<p>Sets the priming/bolus rate (Basic Mode only).</p> <p>X must be an integer or decimal (up to five decimal places) within the rate limits for the syringe (See read limit parameter command).</p> <p>Only one value is required.</p> <p><b>Example</b>  <pre>set primerate 1.0</pre></p> <p>Returns the priming/bolus rate (in Basic Mode).</p>
restart	<p>Powers off and then automatically powers on the pump.</p>

In some cases, depending on the software used to connect to the pump, each command may need to be followed by a line feed character such as “\n” or “\r” to execute. If a command does not appear to work, try adding “\r” or “\n” to the end of the line.

**Example**

```
set units 1 \r
```

When the pump does not recognize a command, it will return text similar to the following:

**Example**

```
Command not recognized-type in "help"
and press enter to see a command list.
```

## Chemyx Pump Controller Programs

In addition to the manual control of the pumps through a terminal, Chemyx provides pump controller programs as an unsupported open-source applications written in Python, a LabVIEW package, and a MATLAB package. More information on these tools can be found on the website at [www.chemyx.com/support](http://www.chemyx.com/support).

**Chemyx provides free downloads for LabVIEW™ and MATLAB™ as a courtesy to our customers. This service is not supported by Chemyx, all customers are responsible for solving any technical issues related to LabView and MATLAB computer control.**

# Warranty and Repair Information

## Warranty Information

Chemyx provides a two-year limited warranty (1) first year for parts and labor (2) second-year for parts only from the shipment date for its pumps against defects in materials and workmanship. Chemyx will repair product that proves defective during its stated warranty period. To get warranty repair the customer is responsible to send the pump to Chemyx.

The foregoing warranty will not apply to damage resulting from:

- ▶ Improper or inadequate maintenance or operation.

---

- ▶ Unauthorized modification or misuse of the product.

---

- ▶ Operation outside the electrical specifications for the product.

---

- ▶ Operation outside the temperature specifications for the product.

---

- ▶ User-induced internal and external contaminations of the instrument.

---

- ▶ Failure to use proper surge protection.

---

- ▶ Improper product return, packaging, and shipping

---

- ▶ Removing serial number from syringe pump

## Repair Information

Chemyx can repair the syringe pump without major damage. You must contact Chemyx Inc by either email or phone before returning the product. Chemyx will issue a Return Authorization (RA) number to you.

You must contact Chemyx (call +1 281-277-5499 or visit [www.chemyx.com/contact-us](http://www.chemyx.com/contact-us)) before returning a product. Chemyx will issue a Return Authorization (RA) number to you.

Return products to:

Chemyx Inc.

10905 Cash Road | Stafford, TX 77477 USA.

## Dead Pixel Policy

During the LCD Monitor manufacturing process, it is not uncommon for one or more pixels to become fixed in an unchanging state. The visible result is a fixed pixel that appears as an extremely tiny, dark or bright dot. In almost every case, these fixed pixels are hard to see and do not detract from display quality or usability. A display with three to seven bright or dark dots is considered normal and within industry standards. If your screen displays more than seven dead pixels during the warranty period, your system will qualify for warranty replacement. Please see the Limited Warranty section for details on how to activate a warranty claim.

## Serial Numbers

The serial number is located on the back, top left corner or center of the pump under a small barcode. Removal of the serial number label will void the warranty.

## Calibrations

Chemyx pumps are pre-calibrated upon arrival to your site. All calibrated parameters are within stated accuracy and precision specifications of the pump. Although the pump is highly accurate, syringes of different materials can attribute significant volume errors. Typically, these errors can range from 1% for glass syringes to 5% for plastic syringes. Chemyx is not responsible for errors generated from syringes.

# Pump Maintenance

## Lubricating the Pump

Pump lubrication is the most important part of regular pump maintenance. Proper lubrication ensures long service life, smooth flow performance, and protection against corrosive lab fumes. The pump may not be adequately cleaned and lubricated if the following occur: (1) grinding sounds are coming from the lead screw; (2) the block release button decouples under the load before the pump stalls; or (3) the pump stalls with increased frequency.

## Lubrication Instructions

1. Clean contact surfaces with a clean cloth. Remove any debris on the lead screw and the guide rods.
2. Apply lubricant along the length of the lead screw and the guide rods.
3. Press the block-release button and slide the pusher block to the left edge.
4. Run the pump end-to-end without a syringe to work the lubricant into the components.

Pump lubrication should be performed every three months.

## Approved Lubricants

- Engine/motor oil
- Silicone oil
- Machine oil
- Tooling oil or “WD-40”
- Lithium-based grease

Please contact Chemyx (call +1 281-277-5499 or visit [www.chemyx.com/contact-us](http://www.chemyx.com/contact-us)) to confirm the safe use of a different lubricant.

# Syringe Pump Accessories



**Stainless Steel Syringes**

Machined for high-pressure applications, built with marine-grade molybdenum-alloyed steel, these precision-machined syringes are resistant to corrosive materials. See also our accompanying replacement o-rings, sized to coordinate with Chemyx syringes. For more information visit [chemyx.com/products/stainless-steel-syringes/](http://chemyx.com/products/stainless-steel-syringes/)

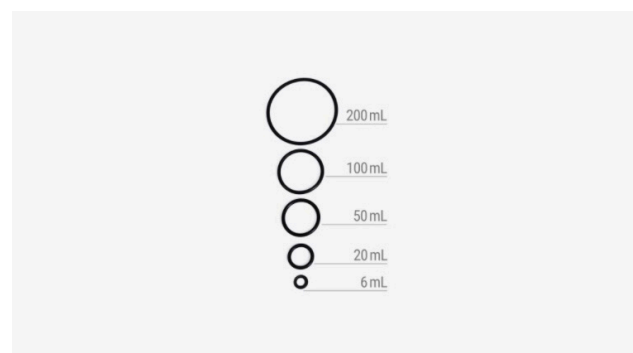

**O-Ring**

Made with a copolymer of butadiene and acrylonitrile, the Chemyx Buna-N/Nitrile/NBR seals offer compression-set resistance and are designed to resist most oils, lubricants, and hydrocarbon fuels. Our most popular syringe pump seals, the Buna-N syringe O-ring replacements, are effective from -22°F to 250°F (-30°C to 121°C), offer superior abrasion and tear resistance, and are best for heavy-duty industrial applications, for use with and sized according to our Chemyx Stainless-Steel Syringes.



**Footswitch**

Streamline laboratory operations with this electric foot switch control that lets you start, stop, or pause your Chemyx syringe pump systems—even when your hands are full. The electric foot pedal switch connects seamlessly to computerized pumping programs, and its 10-foot cable connection can be customized for either the Nexus series (DB9 connection) or the Fusion 100/200/4000-X/6000 (USB-B connection).



**USB Cable**

Connect your Chemyx syringe pump directly to any computer with this 6-ft USB-B cable. This communication USB cable can connect with any of the Chemyx syringe pump systems to allow full remote control through a variety of automation programs, such as LabVIEW and MATLAB.



# Syringe Pump Accessories



**RS232 Cable**

Remotely control your Chemyx syringe pump from any computer with this 6-foot RS232 cable. The RS232 cable ensures a quick and easy setup for seamless device communication with automation software such as LabVIEW and MATLAB to streamline your laboratory workflow. Each end of the RS232 cable connects to a 9-pin port (DB9).

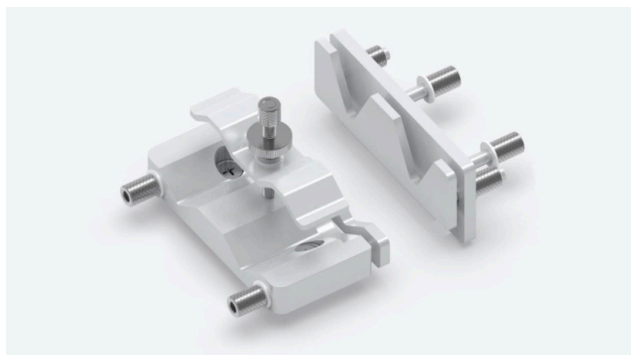

**Dual Syringe Holding Rack**

The Dual Syringe Holding Rack is only compatible with the Fusion 4000-X Syringe Pump. It allows for up to two syringes to be used symontenisoly.

# Appendices

## Appendix A: Syringe Volume/ Inner Diameter Reference

### CHEMYX STAINLESS STEEL

Size	Diameter
6.00 mL	9.53 mm
20.00 mL	19.13 mm
50.00 mL	28.6 mm

### BD GLASS

Size	Diameter
0.50 mL	4.64 mm
1.00 mL	4.64 mm
2.00 mL	8.93 mm
2.50 mL	8.66 mm
3.00 mL	8.93 mm
5.00 mL	11.73 mm
10.00 mL	14.68 mm
20.00 mL	19.60 mm
30.00 mL	22.70 mm
50.00 mL	28.03 mm
60.00 mL	28.60 mm

### BD PLASTIC

Size	Diameter
1.00 mL	4.64 mm
3.00 mL	4.64 mm
5.00 mL	12.07 mm
10.00 mL	14.50 mm
20.00 mL	19.13 mm
30.00 mL	21.69 mm
60.00 mL	26.72 mm

### HAMILTON GLASS

Size	Diameter
0.50 µL	0.10 mm
1.00 µL	0.15 mm
2.00 µL	0.21 mm
5.00 µL	0.33 mm
10.00 µL	0.48 mm
25.00 µL	0.73 mm
50.00 µL	1.03 mm
100.00 µL	1.46 mm
250.00 µL	2.30 mm
500.00 µL	3.26 mm
1.00 mL	4.61 mm
2.50 mL	7.28 mm
5.00 mL	10.30 mm
10.00 mL	14.57 mm
25.00 mL	23.03 mm
50.00 mL	32.57 mm

### HOSHI

Size	Diameter
1.00 mL	4.80 mm
1.00 mL	6.70 mm
2.00 mL	6.70 mm
2.00 mL	9.20 mm
3.00 mL	10.30 mm
5.00 mL	12.20 mm
10.00 mL	15.00 mm
20.00 mL	19.00 mm
30.00 mL	22.50 mm
50.00 mL	25.50 mm
100.00 mL	34.00 mm

### JMC AIR-TITE PLASTIC

Size	Diameter
1.00 mL	4.66 mm
2.00 mL	6.90 mm
2.50 mL	9.10 mm
5.00 mL	12.62 mm
10.00 mL	14.34 mm
20.00 mL	19.68 mm
30.00 mL	22.44 mm
50.00 mL	28.80 mm
100.00 mL	36.68 mm

### NATSUME

Size	Diameter
0.25 mL	2.60 mm
0.50 mL	3.20 mm
1.00 mL	4.30 mm
2.00 mL	6.30 mm
3.00 mL	7.30 mm
5.00 mL	9.50 mm

### NIPRO

Size	Diameter
1.00 mL	4.71 mm
3.00 mL	9.50 mm
5.00 mL	12.91 mm
10.00 mL	15.40 mm
20.00 mL	19.30 mm
30.00 mL	23.40 mm
50.00 mL	29.00 mm

### NORM-JECT PLASTIC

Size	Diameter
1.00 mL	4.70 mm
2.50 mL	9.70 mm
5.00 mL	12.48 mm
10.00 mL	15.89 mm
20.00 mL	20.00 mm
30.00 mL	22.50 mm
50.00 mL	28.90 mm

### POPPER & SONS GLASS

Size	Diameter
0.25 mL	3.45 mm
0.50 mL	3.45 mm
1.00 mL	4.50 mm
2.00 mL	8.92 mm
3.00 mL	8.99 mm
5.00 mL	11.70 mm
10.00 mL	14.70 mm
20.00 mL	19.58 mm
30.00 mL	22.70 mm
50.00 mL	29.00 mm

### RANFAC

Size	Diameter
2.00 mL	9.12 mm
5.00 mL	12.34 mm
10.00 mL	14.55 mm
20.00 mL	19.86 mm
30.00 mL	23.20 mm
50.00 mL	27.60 mm

## SGE GLASS

Size	Diameter
25.00 µL	0.73 mm
50.00 µL	1.03 mm
100.00 µL	1.46 mm
250.00 µL	2.30 mm
500.00 µL	3.26 mm
1.00 mL	4.61 mm
2.50 mL	7.28 mm
5.00 mL	10.30 mm
10.00 mL	14.57 mm

## SHERWOOD PLASTIC

Size	Diameter
1.00 mL	4.65 mm
3.00 mL	8.94 mm
6.00 mL	12.70 mm
12.00 mL	15.90 mm
20.00 mL	20.40 mm
35.00 mL	23.80 mm
50.00 mL	26.60 mm

## TERUMO

Size	Diameter
1.00 mL	4.73 mm
3.00 mL	9.00 mm
5.00 mL	13.04 mm
10.00 mL	15.79 mm
20.00 mL	20.18 mm
30.00 mL	23.36 mm
60.00 mL	29.45 mm

## TERUMO JAPAN

Size	Diameter
1.00 mL	4.73 mm
1.00 mL	6.50 mm
3.00 mL	8.65 mm
5.00 mL	13.00 mm
10.00 mL	15.80 mm
20.00 mL	20.15 mm
30.00 mL	23.10 mm
50.00 mL	29.10 mm

## TOP

Size	Diameter
1.00 mL	4.70 mm
2.00 mL	6.40 mm
3.00 mL	9.30 mm
6.00 mL	13.10 mm
12.00 mL	15.40 mm
25.00 mL	21.00 mm
30.00 mL	23.00 mm
50.00 mL	29.00 mm

## UNIMETRICS

Size	Diameter
10.00 µL	0.46 mm
25.00 µL	0.73 mm
50.00 µL	1.03 mm
100.00 µL	1.46 mm
250.00 µL	2.30 mm
500.00 µL	3.26 mm
1000.00 µL	4.61 mm

## KENDALL MONOJECT PLASTIC

Size	Diameter
1.00 mL	4.65 mm
3.00 mL	8.94 mm
6.00 mL	12.70 mm
12.00 mL	15.90 mm
20.00 mL	20.40 mm
35.00 mL	23.80 mm
60.00 mL	26.60 mm